

PAJUNK®



Regional Anesthesia *Product Catalogue*



2ND GENERATION

MADE IN GERMANY 

PIONEER OF SPINAL ANAESTHESIA THE SPROTTE®



First Atraumatic Needle – 1979

Sprotte

- The **ogive shaped tip** significantly reduces trauma to the dura mater and minimises the risk of PDPH¹
- Unobstructed backflow and quicker CSF flashback²
- Lateral Eye with burr-free, rounded edges optimises gliding properties and minimises chance of tissue coring and carry-over into the subarachnoid space
- Precision-ground metal stylet closes lateral eye precisely to minimise chance of tissue coring³

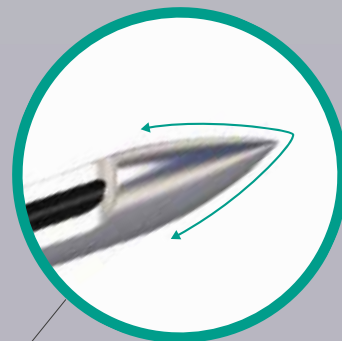

Atraumatic Tip Design

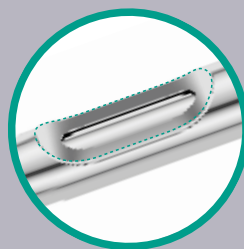
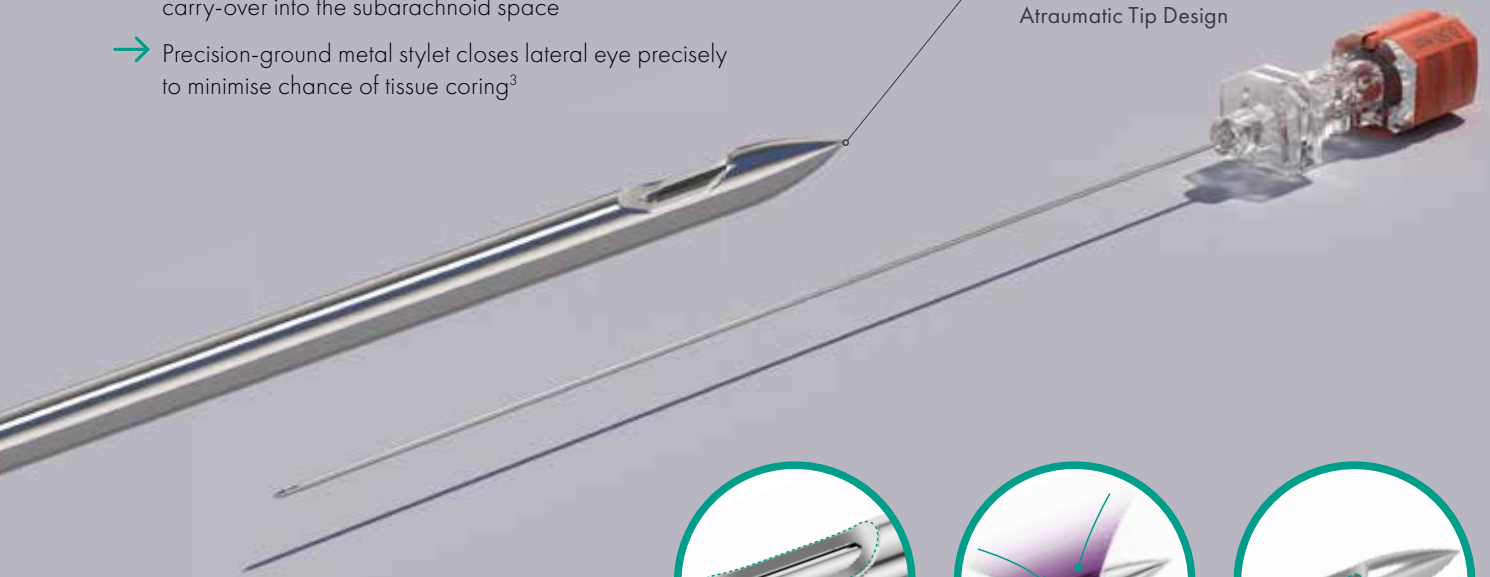

Lateral Eye

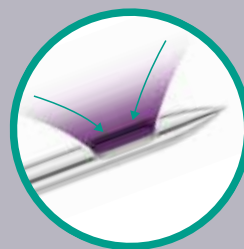

Optimal Lateral Eye Size and Placement

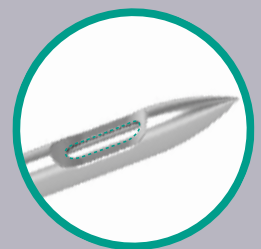

Precision-Ground Metal Stylet

¹ Cesarini, M. et al. Sprotte needle for intrathecal anaesthesia for Caesarean section: incidence of postdural puncture headache., *Anaesthesia* 1990; 45: 646–658
² Saenghirunvattana R. et al. A comparison study between newly-designed pencil-point and cutting needles in spinal anaesthesia, *J. Med. Assoc. Thai.* 2008; 91 (Suppl 1): S156–161
³ Armon C., Evans R. W. Addendum to assessment: Prevention of postlumbar puncture headaches Report of the Therapeutics and Technology Assessment Subcommittee of the American Academy of Neurology., *Neurology.*, 2005; 65; 510

Table of Contents

1 | SPINAL ANESTHESIA

<i>SPROTTE®</i>	6
<i>Sprotte Introducer</i>	8
<i>IntraLong</i>	9

2 | EPIDURAL ANESTHESIA

<i>TuohySono</i>	12
<i>Tuohy II</i>	13
<i>Caudal</i>	14
<i>EpiLong (Soft) Cath</i>	15
<i>EpiLong II</i>	16
<i>EpiLong II Soft</i>	17

3 | COMBINED SPINAL-EPIDURAL ANESTHESIA

<i>EpiSpin Lock Needles</i>	20
<i>EpiSpin II Safety</i>	21
<i>EpiSpin Lock</i>	22
<i>EpiSpin Lock Soft</i>	23

4 | NERVE BLOCKS

<i>Single Shot Needles</i>	
<i>SonoPlex® II</i>	26
<i>SonoBlock II</i>	27
<i>SonoTAP® II</i>	28
<i>TuohySono</i>	29
<i>SonoEye</i>	30
<i>UniPlex®</i>	31

Table of Contents

4 | NERVE BLOCKS

Catheter Sets

<i>E-Cath® II</i>	32
<i>E-Cath® II Plus</i>	33
<i>SonoLong Echo</i>	34
<i>SonoLong SoftSecure</i>	35
<i>SonoLong Curl Echo</i>	36
<i>StimuLong Sono II</i>	37
<i>PlexoLong NanoLine®</i>	38

5 | WOUND INFILTRATION

Local Infiltration Analgesia

<i>InFiltr</i>	42
----------------	----

Continuous Wound Infiltration

<i>InfiltraLong</i>	43
<i>InfiltraLong TUN</i>	44
<i>InfiltraLong TUN Duo</i>	45

Continuous Infiltration Pump

<i>FuserPump, single</i>	46
<i>FuserPump</i>	47
<i>FuserPump TUN</i>	48

6 | ACCESSORIES

<i>LOR, NerveGuard, FuserPump Filler, Clamping Adapter, FixoCath, Filter & FixoLong, Injection Tubing, NRFit® Accessories, SonoCover</i>	50
--	----

Spinal Anesthesia

*Needles and Catheters for Atraumatic
Spinal Anesthesia*



SPROTTE®

Needles for Atraumatic Spinal Anesthesia with Standard Hub or Magnifying Hub

- 1 Atraumatic Tip Design
- 2 Lateral Eye
- 3 Precision-ground Metal Stylet
- 4 Standard Hub
- 5 Alternatively: Magnifying Hub
- 6 Highest Processing Quality

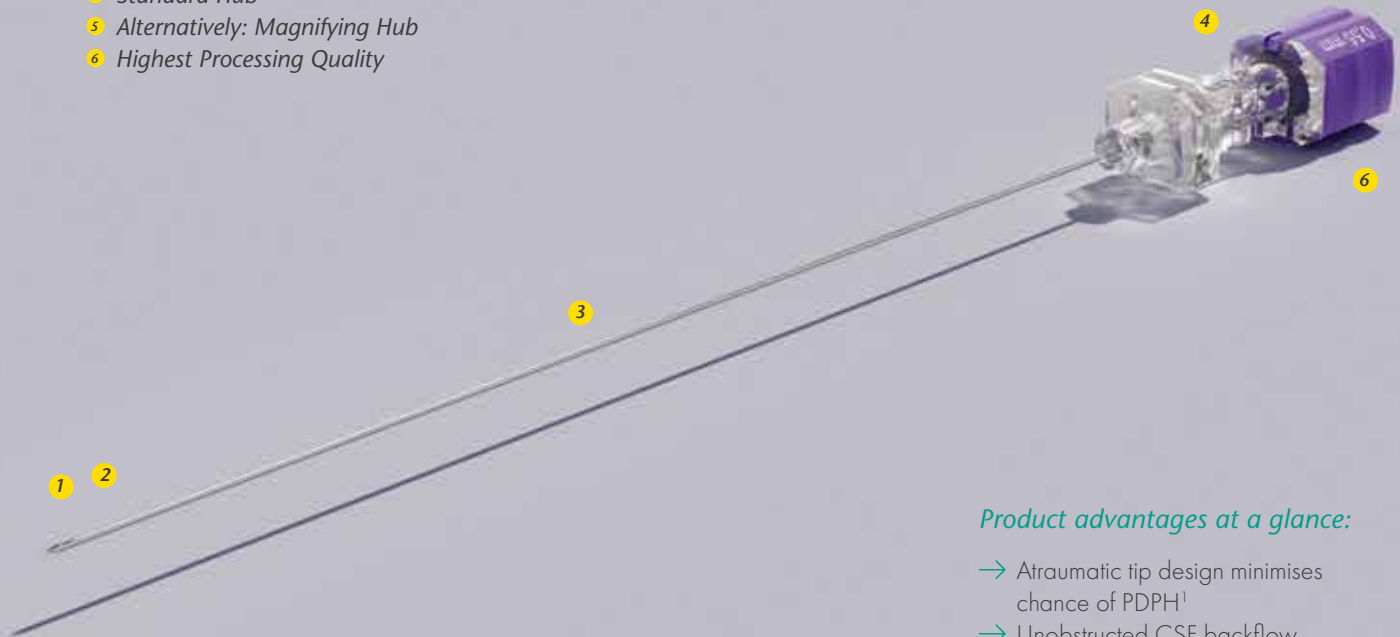

Product advantages at a glance:

- Atraumatic tip design minimises chance of PDPH¹
- Unobstructed CSF backflow
- Smooth gliding properties and improved tactile feedback

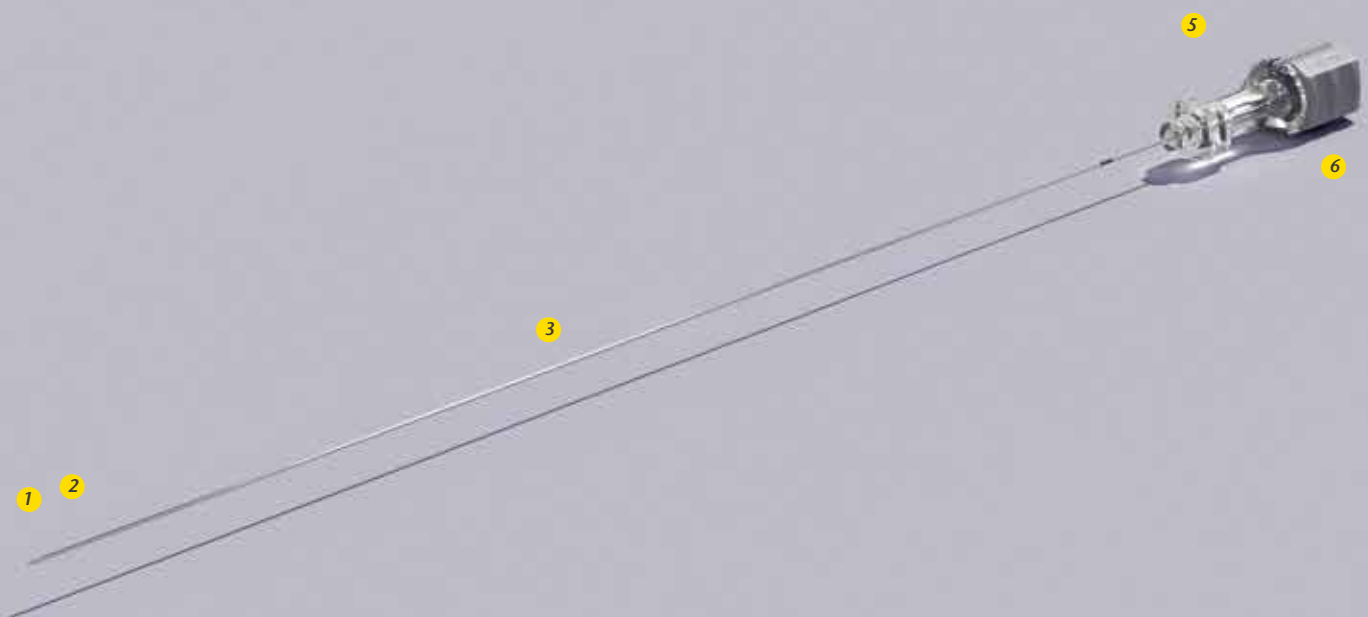

1. Cesarini, M. et al. Sprotte needle for intrathecal anaesthesia for Caesarean section: incidence of postdural puncture headache, *Aesthesia* 1990; 45: 646-658

Sprotte Needles with Standard Hub/Magnifying Hub

Description	Introducer	Item no. Standard hub	Item no. Magnifying hub	NRFit® Item no. Magnifying hub	NRFit Sets* Item no. Magnifying hub	PU
• 27G x 35 mm (1 1/3")			111151-27A			25
27G x 90 mm (3 1/2")	30 mm (1 1/5")		121151-27A	021163-27A		25
27G x 90 mm (3 1/2")	30 mm (1 1/5")				021166-27A	10
27G x 90 mm (3 1/2")	40 mm (1 3/5")			211163-27A		25
27G x 103 mm (4")	40 mm (1 3/5")		141151-27A	041163-27A		25
27G x 120 mm (4 3/4")	40 mm (1 3/5")		151151-27A	031163-27A		10
27G x 123 mm (4 4/5")			231151-27A			10
26G x 90 mm (3 1/2")	30 mm (1 1/5")	121151-26A		121163-26A		25
26G x 103 mm (4")	40 mm (1 3/5")	021151-26A		021163-26A		25
26G x 120 mm (4 3/4")	40 mm (1 3/5")	041151-26A		041163-26A		10
• 25G x 35 mm (1 1/3")		001151-29E		001163-29E		25
25G x 90 mm (3 1/2")	30 mm (1 1/5")	021151-29A	511151-29A	021163-29A		25
25G x 90 mm (3 1/2")	30 mm (1 1/5")				021166-29A	10
25G x 90 mm (3 1/2")	40 mm (1 3/5")			211163-29A		25
25G x 90 mm (3 1/2")	40 mm (1 3/5")				211166-29A	10
25G x 103 mm (4")	40 mm (1 3/5")	041151-29A	161151-29A	041163-29A		25
25G x 120 mm (4 3/4")		031151-29A				10
25G x 120 mm (4 3/4")	40 mm (1 3/5")	051151-29A	171151-29A	051163-29A		10
25G x 123 mm (4 4/5")		151151-29A				10
25G x 150 mm (6")	40 mm (1 3/5")	061151-29A				10
• 24G x 35 mm (1 1/3")		001151-30E		001163-30E		25
24G x 90 mm (3 1/2")		001151-30A		001163-30A		25
24G x 90 mm (3 1/2")	30 mm (1 1/5")	121151-30A		121163-30A		25
24G x 90 mm (3 1/2")	30 mm (1 1/5")				121166-30A	10
24G x 103 mm (4")	40 mm (1 3/5")	021151-30A		021163-30A		25
24G x 103 mm (4")	40 mm (1 3/5")				521166-30A	10
24G x 120 mm (4 3/4")		031151-30A				10
24G x 120 mm (4 3/4")	40 mm (1 3/5")	041151-30A		041163-30A		10
24G x 150 mm (6")	40 mm (1 3/5")	131151-30A		131163-30A		10
• 22G x 50 mm (2")		071151-30C		071163-30C		25
22G x 90 mm (3 1/2")		001151-30C		001163-30C		25
22G x 90 mm (3 1/2")	30 mm (1 1/5")	021151-30C		021163-30C		25
22G x 90 mm (3 1/2")	30 mm (1 1/5")				021166-30C	10
22G x 103 mm (4")	40 mm (1 3/5")	221151-30C		221163-30C		25
22G x 120 mm (4 3/4")	40 mm (1 3/5")	131151-30C		131163-30C		10
22G x 150 mm (6")	40 mm (1 3/5")	141151-30C		141163-30C		10

• Small patient product

*NRFit Sets include a Filter Needle NRFit 18G x 50mm (2"), Syringe NRFit 3 ml Slip, Syringe NRFit 5 ml Slip

SPROTTE® Introducer

Matching Introducer for
Sprotte Spinal Needles

- 1 Facet Tip
- 2 Match Perfectly to Each Spinal Needle Size

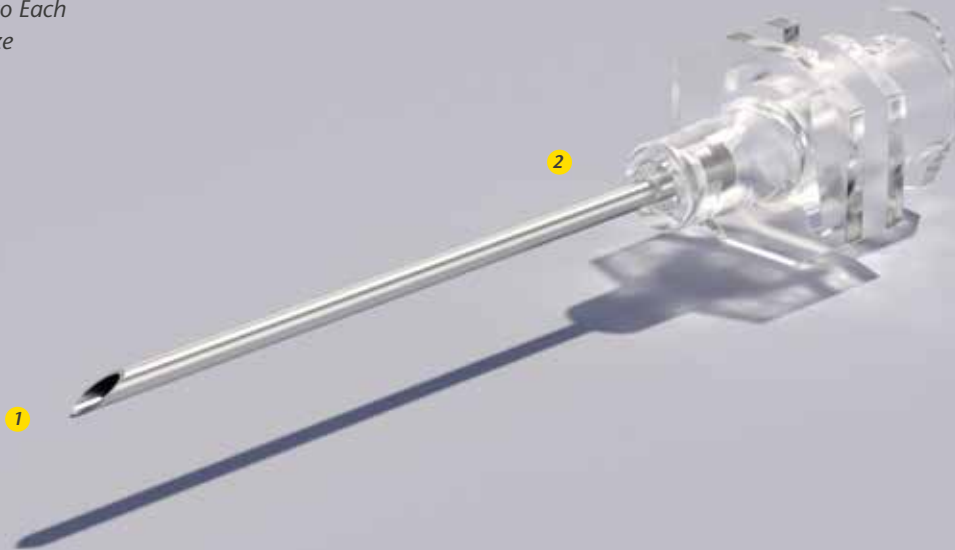

Product advantages at a glance:

- Minimal reduction of useable working length of the spinal needle
- Funnel-shaped hub to reduce chance of spinal needle tip damage during insertion

Description	Sprotte Size	Item no.	NRFit® Item no.	PU
20G x 30 mm (1.00 mm x 1 1/5")	22G	001151-30L	001163-30L	25
20G x 40 mm (1.00 mm x 1 3/5")	22G	001151-30M	001163-30M	25

IntraLong

Catheter Set for Continuous Spinal Anesthesia

- 1 Atraumatic Tip Design
- 2 Sprotte Special Tip with Ramp
- 3 Lateral Eye
- 4 Precision-ground Metal Stylet
- 5 Standard Hub
- 6 Highest Processing Quality
- 7 Catheter with Three Lateral Openings, Steel Stylet and Depth Markings

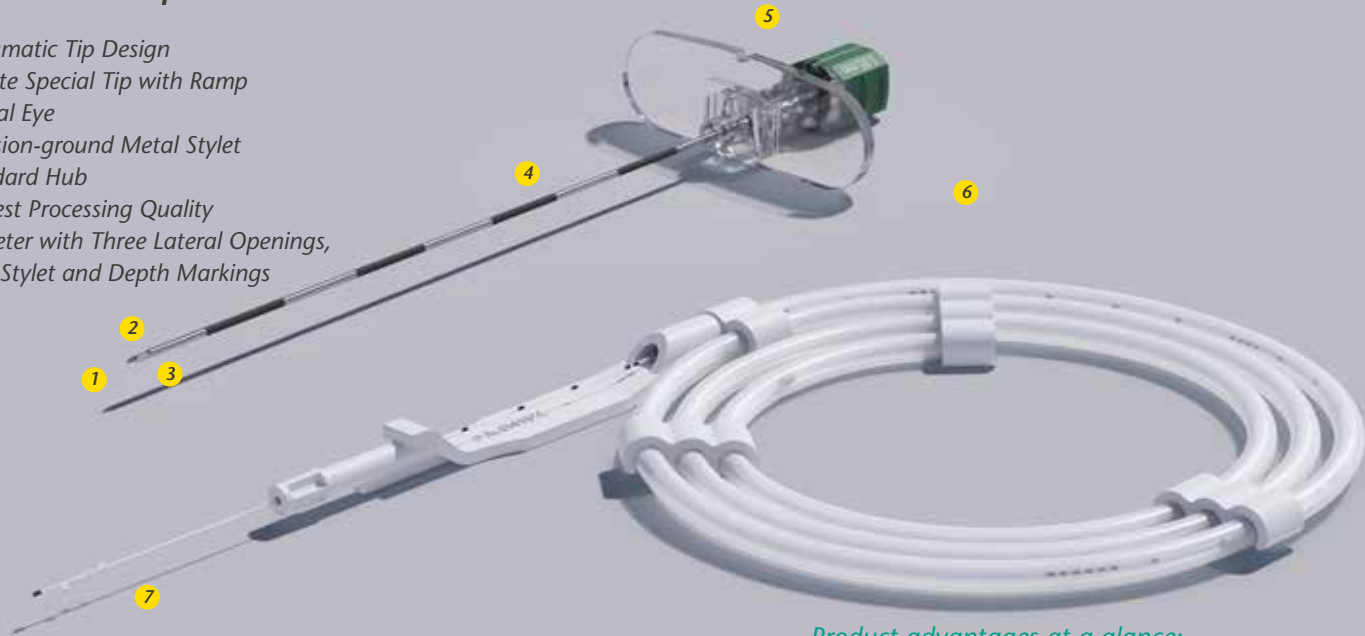

Product advantages at a glance:

- Atraumatic tip design minimises chance of PDPH¹
- Unobstructed CSF backflow
- Smooth gliding properties and improved tactile feedback
- Improved flow of anaesthetic

Description	Catheter	Item no.	NRFit Item no.	PU	Filter	Clamping Adapter	1 ml Luer syringe
21 G x 90 mm (3 1/2")	25 G x 90 cm (35")	31151-30GS	22161-30GS	10	•	•	•

1. Cesarini, M. et al. Sprotte needle for intrathecal anaesthesia for Caesarean section: incidence of postdural puncture headache, *Anaesthesia* 1990; 45: 646-658

WE ARE PAJUNK®
Your partner, always at your service.



EpiLong II Sets for Epidural Anesthesia

Tuohy II

- Thanks to the curved Tuohy tip, the catheter automatically bends when the catheter egresses, placing it in the correct position
- Integrated ergonomic wings for optimal handling for different gripping techniques

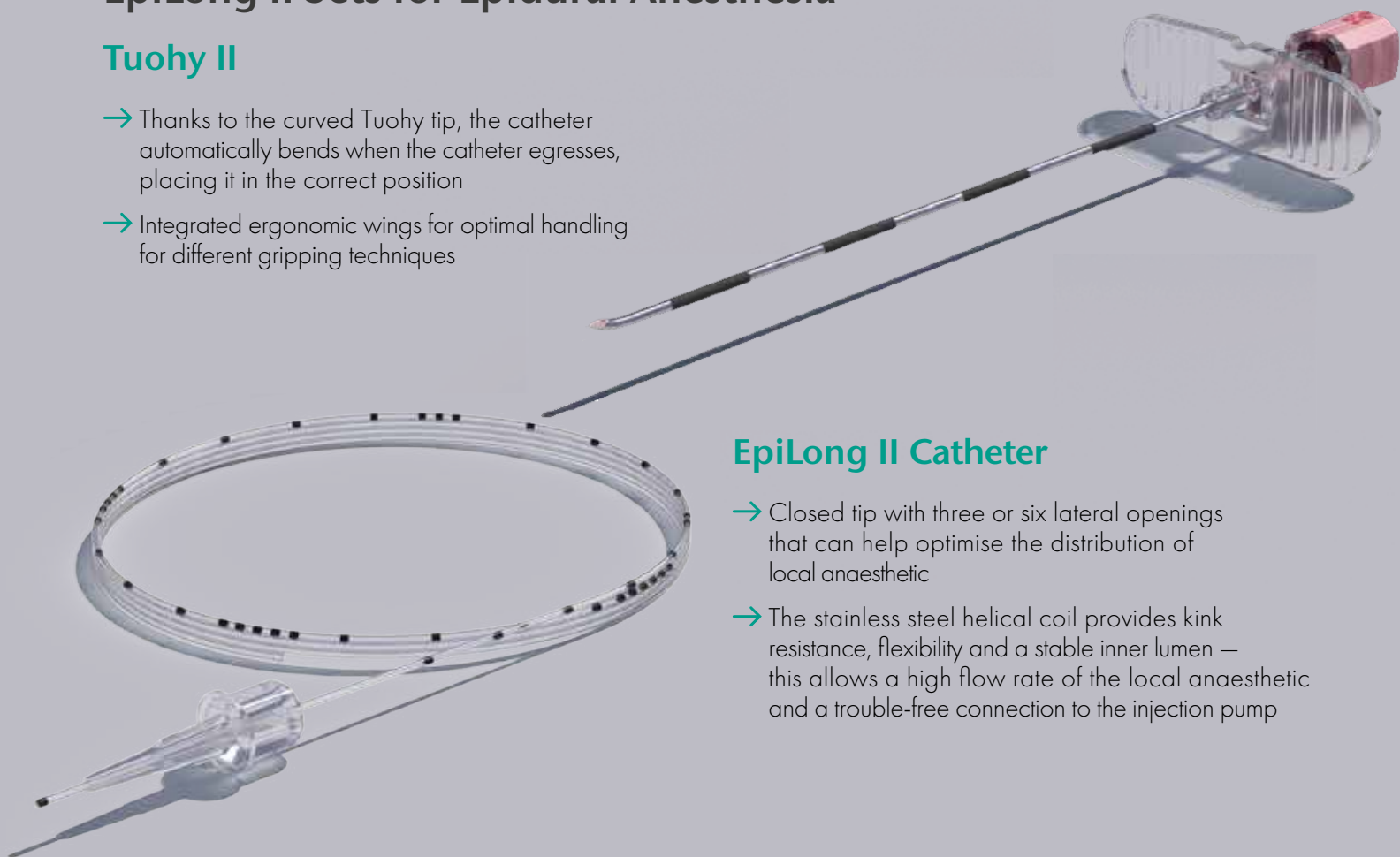

EpiLong II Catheter

- Closed tip with three or six lateral openings that can help optimise the distribution of local anaesthetic
- The stainless steel helical coil provides kink resistance, flexibility and a stable inner lumen — this allows a high flow rate of the local anaesthetic and a trouble-free connection to the injection pump



LEARN MORE AT
info@pajunk.com · pajunk.com

PAJUNK®

Epidural Anesthesia

*Wide Range of
Needles and Catheter Systems*



TuohySono

Echogenic, Single Shot Epidural Injection Needles

- 1 Echogenic Needle Tip
- 2 Cornerstone Reflectors
- 3 Depth Markings
- 4 Precision-ground Metal Stylet
- 5 Detachable Plastic Wings

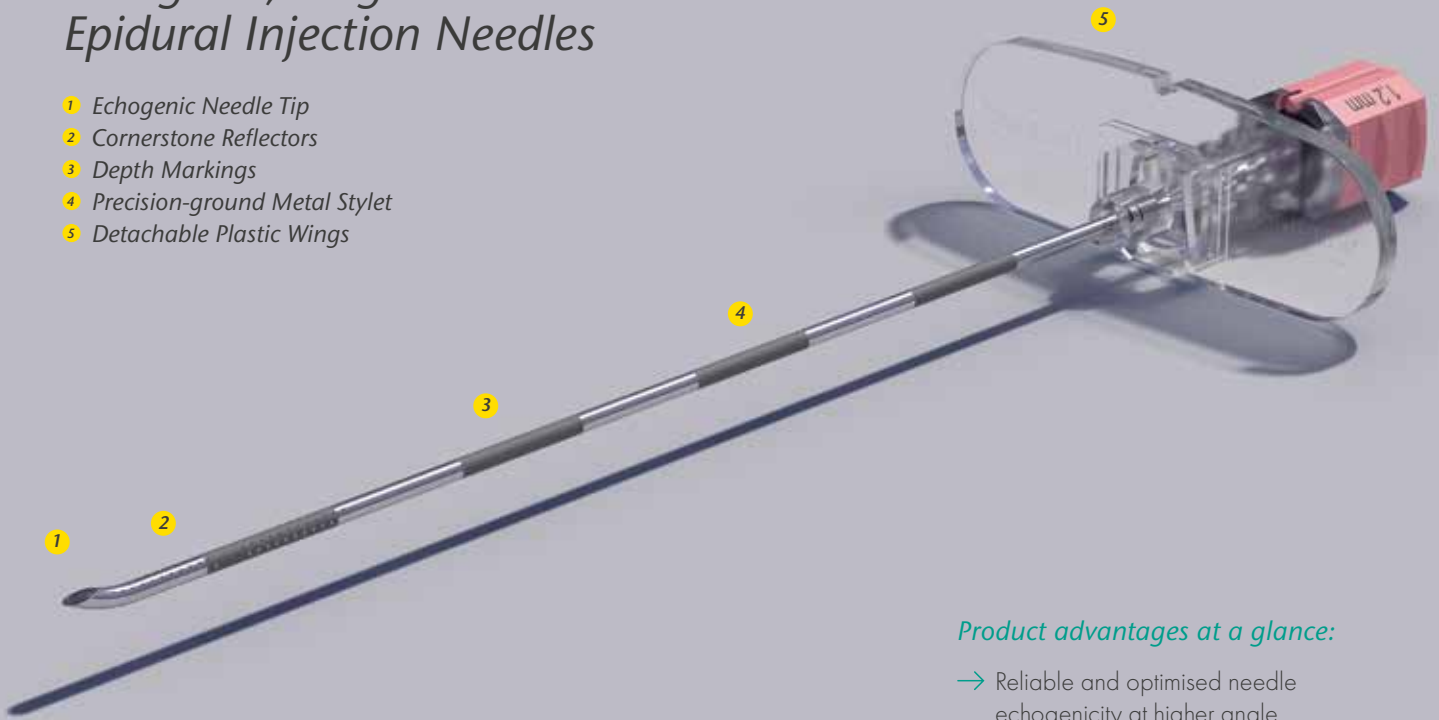

Product advantages at a glance:

- Reliable and optimised needle echogenicity at higher angle
- Optimised ultrasound visibility of needle shaft
- Minimised tissue coring
- Smooth gliding properties
- Optimum handling for different gripping techniques

Description	Item no.	PU
21G x 90mm	1085-4F090	25
• 18G x 50mm (2")	1085-4K050	25
18G x 90mm (3 1/2")	1085-4K090	25
18G x 120mm (4 3/4")	1085-4K120	10
17G x 90mm (3 1/2")	1085-4M090	25

- Small patient product

Tuohy II

Single Shot Epidural Injection Needles

- 1 Depth Markings
- 2 Precision-ground Plastic Stylet
- 3 Integrated Ergonomic Wings



Product advantages at a glance:

- Minimised tissue coring
- Smooth gliding properties
- Optimum handling for different gripping techniques

Description	Item no.	NRFit® Item no.	PU
19G x 90mm (3 1/2")	1170-6I091	1176-6I091	10
18G x 80mm (3 1/4")	1170-6K081	1176-6K081	10
18G x 90mm (3 1/2")	1170-6K091	1176-6K091	10
18G x 120mm (4 3/4")	1170-6K120	1176-6K120	10
17G x 90mm (3 1/2")	1170-6M091	1176-6M091	10
17G x 120mm (4 3/4")	1170-6M120	1176-6M120	10

Caudal

Injection Needles with Crawford Bevel

- 1 Crawford Tip
- 2 Depth Stop and Depth Markings
- 3 Detachable Plastic Wings

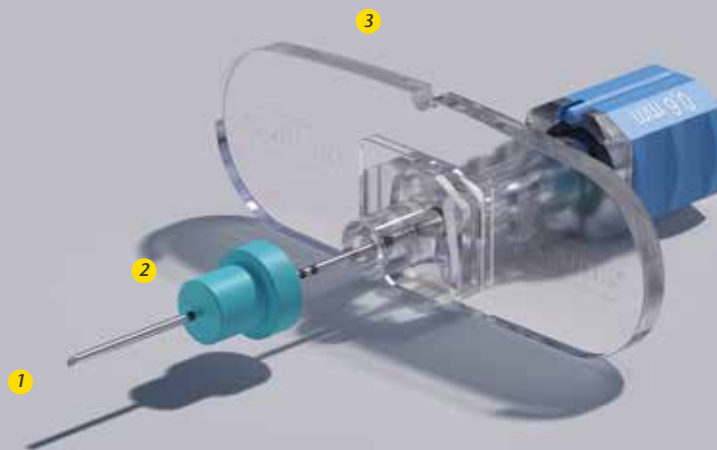

Product advantages at a glance:

- Easy identification of puncture depth
- Optimum handling for different gripping techniques

Description	Item no.	NRFit® Item no.	PU
• 25G x 25 mm (1")		1163-12C025	25
• 23G x 25 mm (1")	1149-12D025		25
• 22G x 40 mm (1 3/5")	1149-12E040	1163-12E040	25
• 22G x 60 mm (2 1/4")	1149-12E060		25

- Small patient product

EpiLong (Soft) Cath

Catheters for Epidural Anesthesia

- 1 Closed Tip and Lateral Openings
- 2 Standard and Soft Catheters
- 3 Depth Markings

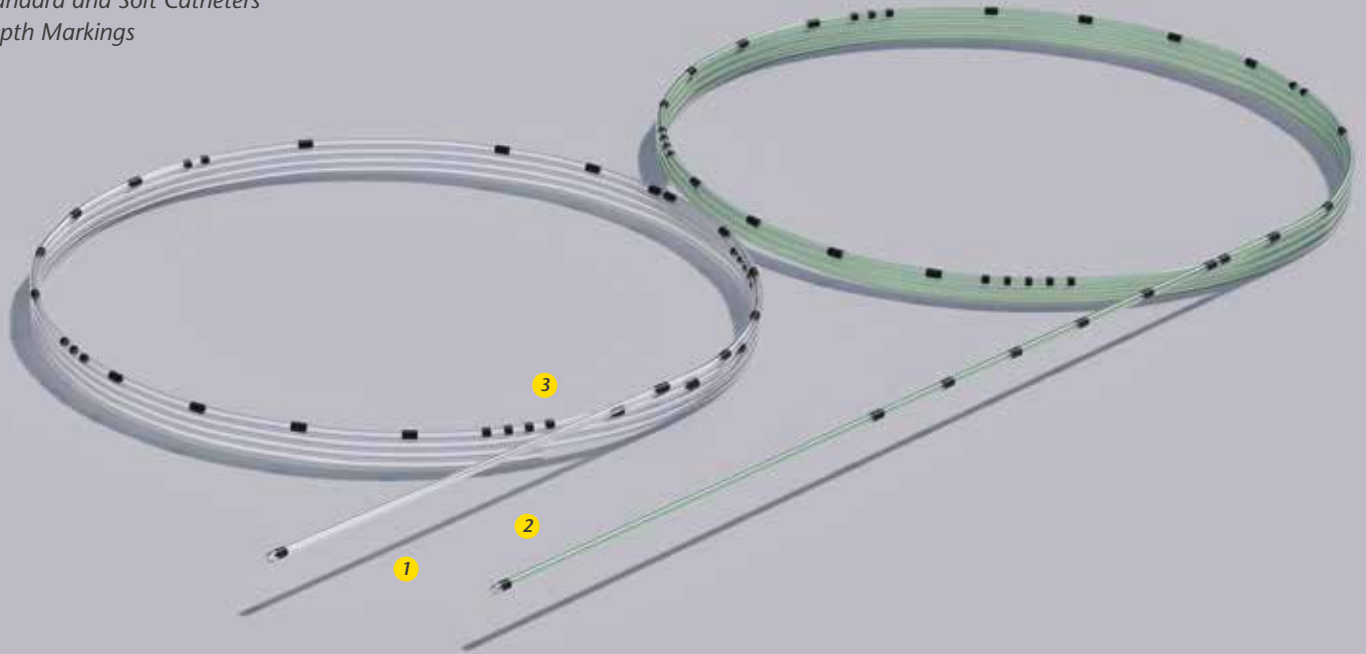

Product advantages at a glance:

- Improved flow of anaesthetic
- Kink resistant (Soft Catheter)

Description	Lateral openings	Item no.	NRFit Item no.	PU	Steel mandrin	Stainless steel helical coil	Clamping Adapter
20G x 90 cm (35")	6	041151-37R	041163-37R	10	•	•	•
19G x 90 cm (35")	6	041151-37P		10		•	•
20G x 90 cm (35")	3	001151-37C		10	•		•
20G x 90 cm (35")	3	021151-37C	021163-37C	10			•
19G x 90 cm (35")	3	001151-37A		10	•		•
19G x 90 cm (35")	3		021163-37A	10			•

EpiLong II

Catheter Sets for Epidural Anesthesia

- 1 Precision-ground Plastic Stylet
- 2 Integrated Ergonomic Wings
- 3 Catheter with Closed Tip and 3 Lateral Openings

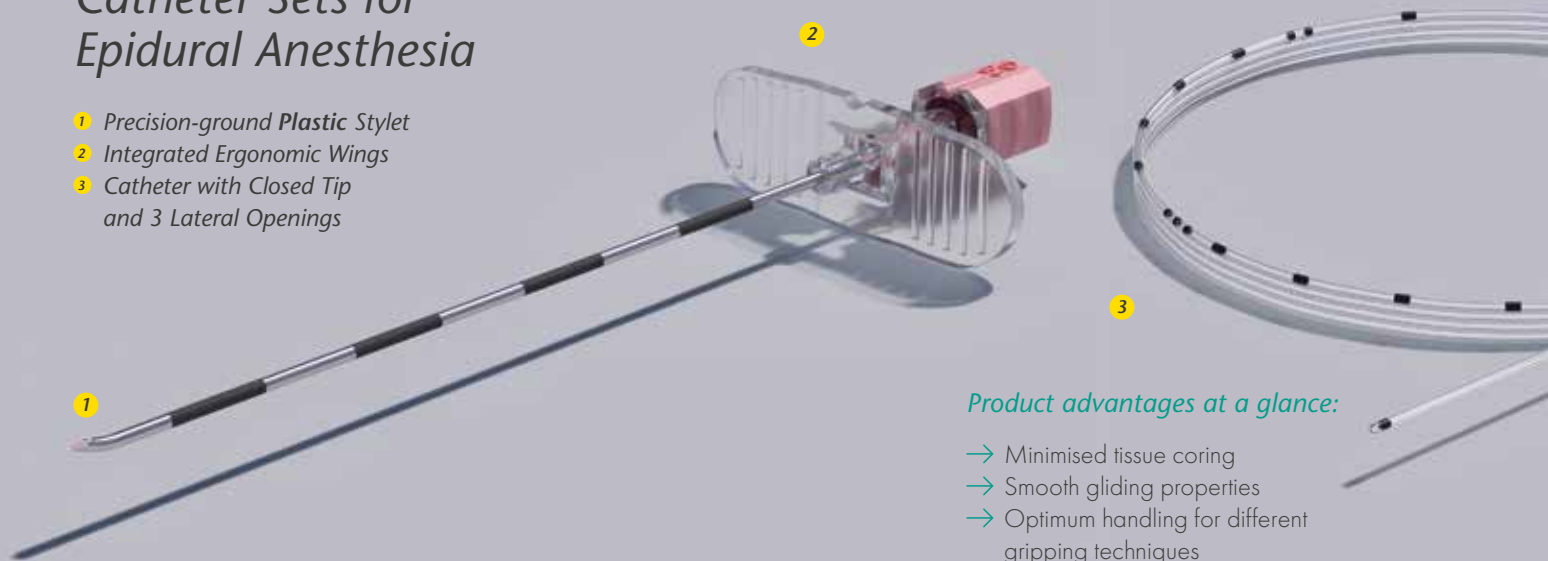

Product advantages at a glance:

- Minimised tissue coring
- Smooth gliding properties
- Optimum handling for different gripping techniques

EpiLong II Description	Catheter	Item no.	NRFit Item no.	NRFit Sets* Item no.	PU	FixoLong	FixoCath	Filter	Clamping Adapter	LOR 7 ml
18G x 80 mm (3 1/4")	20G x 90 cm (35")	033115301-51	033116301-51	133116301-51	10			•	•	•
18G x 80 mm (3 1/4")	20G x 90 cm (35")	053115301-51			10	•		•	•	•
18G x 90 mm (3 1/2")	20G x 90 cm (35")	033115201-51	033116201-51	133116201-51	10			•	•	•
18G x 90 mm (3 1/2")	20G x 90 cm (35")	033125201-51			10		•	•	•	•
18G x 90 mm (3 1/2")	20G x 90 cm (35")	053115201-51			10	•		•	•	•
17G x 80 mm (3 1/4")	19G x 90 cm (35")	033115301-48	033116301-48	133116301-48	10			•	•	•

*NRFit Sets include a Filter Needle NRFit 18G x 50 mm (2"), Syringe NRFit 5 ml Lock, Syringe NRFit 10 ml Lock

EpiLong II Soft

Soft Catheter Sets for Epidural Anesthesia

- 1 Precision-ground **Plastic** Stylet
- 2 Integrated Ergonomic Wings
- 3 Soft Catheter
- 4 Integrated Stainless Steel Helical Coil
- 5 Closed Tip and 6 Lateral Openings

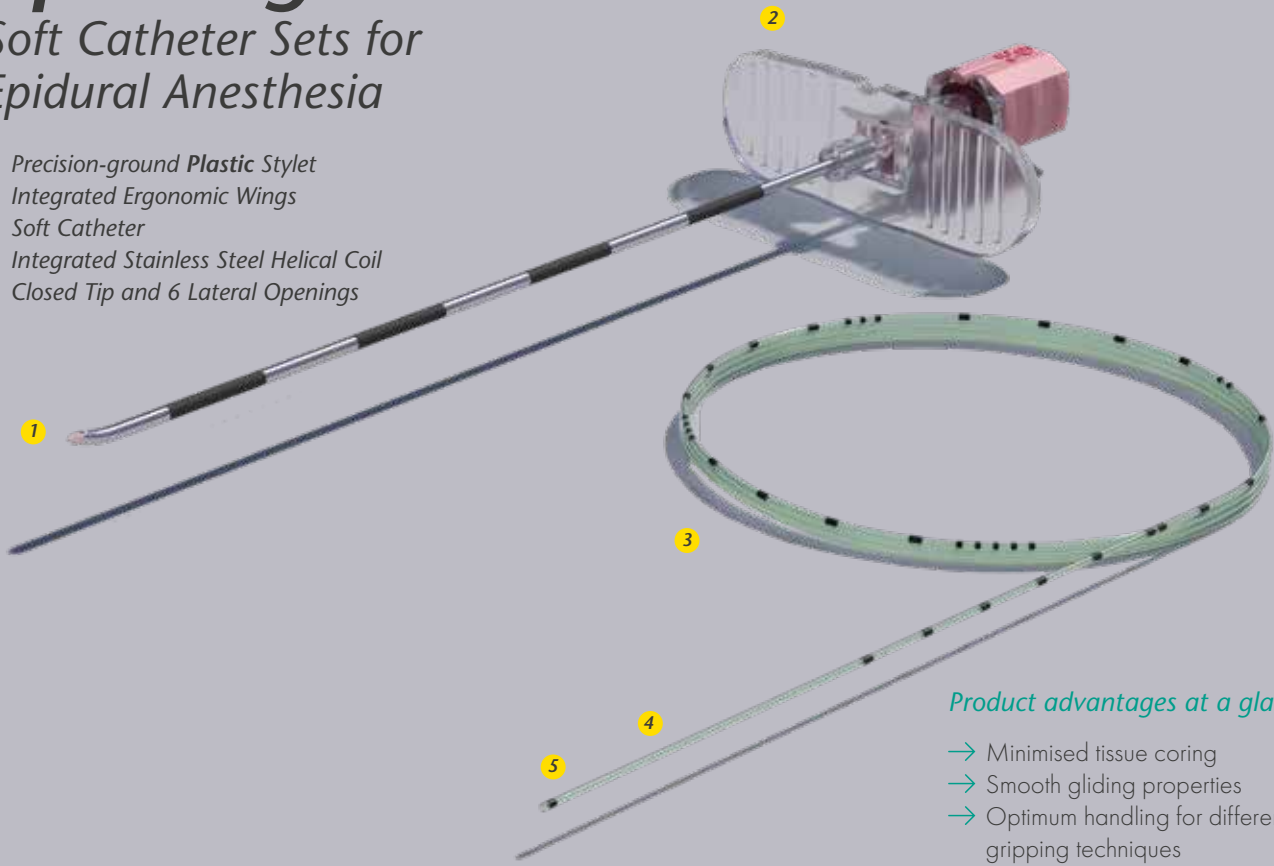

Product advantages at a glance:

- Minimised tissue coring
- Smooth gliding properties
- Optimum handling for different gripping techniques
- Kink resistant

EpiLong II Soft									
Description	Catheter	Item no.	NRFit® Item no.	PU	FixoLong	Filter	Clamping Adapter	LOR 7 ml	
18G x 90 mm (3 1/2")	20G x 90 cm (35")	053115701-51	053116701-51	10	•	•	•	•	
17G x 90 mm (3 1/2")	19G x 90 cm (35")	053115701-48	053116701-48	10	•	•	•	•	

EPI SPIN LOCK & SPROTTE® SURAXIAL ANESTHESIA'S FAVORITE POWER COUPLE

EpiSpin Lock offers smooth and subtle spinal puncture while SPROTTE® minimizes post-spinal headache with the original atraumatic needle.



EpiSpin Lock Combined Spinal-Epidural Anesthesia (CSE)

- 1 Unique Locking System
- SPROTTE locks in place through the back-eye of the Tuohy, removing the need for a third hand
- When Spinal Anesthesia is complete, EpiSpin Lock rotates 90° and easily disconnects from the Tuohy in preparation for Epidural Anesthesia

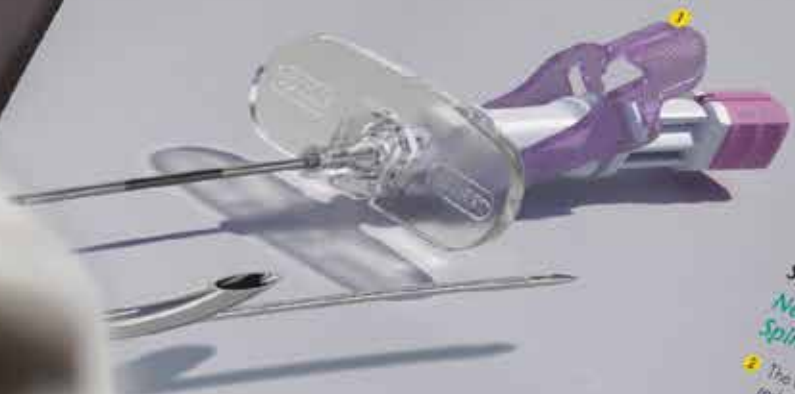

SPROTTE® Needles for Atraumatic Spinal Anesthesia

- 2 The ogive shaped tip significantly reduces the risk of PDPH^{1,2}
- The rounded edges of the lateral eye minimize trauma and provide excellent tactile feedback
- Clear, magnifying needle hub allows for easy visualization of CSF

...PLES & AN ONLINE DEMO NOW!
...pajunkusa.com



30
43
15
16

Combined Spinal-Epidural Anesthesia

Unique Needle Systems for CSE

EpiSpin Lock Needles

Unique CSE Needle Systems with Locking Mechanism

- 1 Unique Locking System
- 2 Back-Eye Opening
- 3 Atraumatic Tip Design
- 4 Magnifying Hub
- 5 Outlet Marking
- 6 Precision-ground Metal Stylet

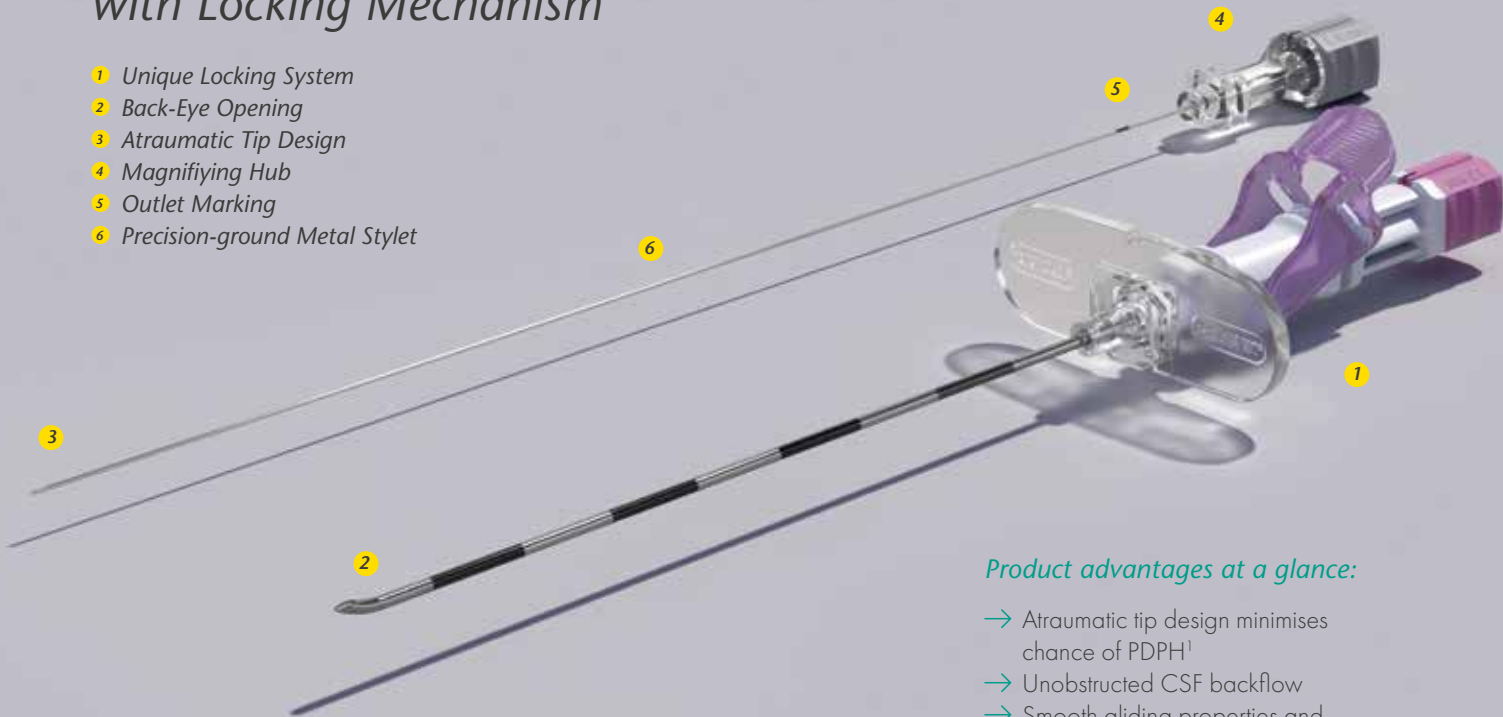

Product advantages at a glance:

- Atraumatic tip design minimises chance of PDPH¹
- Unobstructed CSF backflow
- Smooth gliding properties and improved tactile feedback
- Minimised tissue coring
- Optimum handling for different gripping techniques
- Easily fixation of spinal needle

Description	SPROTTE®	Item no.	NRFit® Item no.	PU
17G x 90mm (3 1/2")	25G	0011351-20		10

Catheters see page 15

EpiSpin II Safety

Unique CSE Catheter Sets with Fixation Device

- 1 Fixation Device
- 2 Back-Eye Design
- 3 Atraumatic Tip Design
- 4 Magnifying Hub
- 5 Outlet Marking
- 6 Precision-ground Metal Stylet
- 7 Catheter with Closed Tip and 3 Lateral Openings

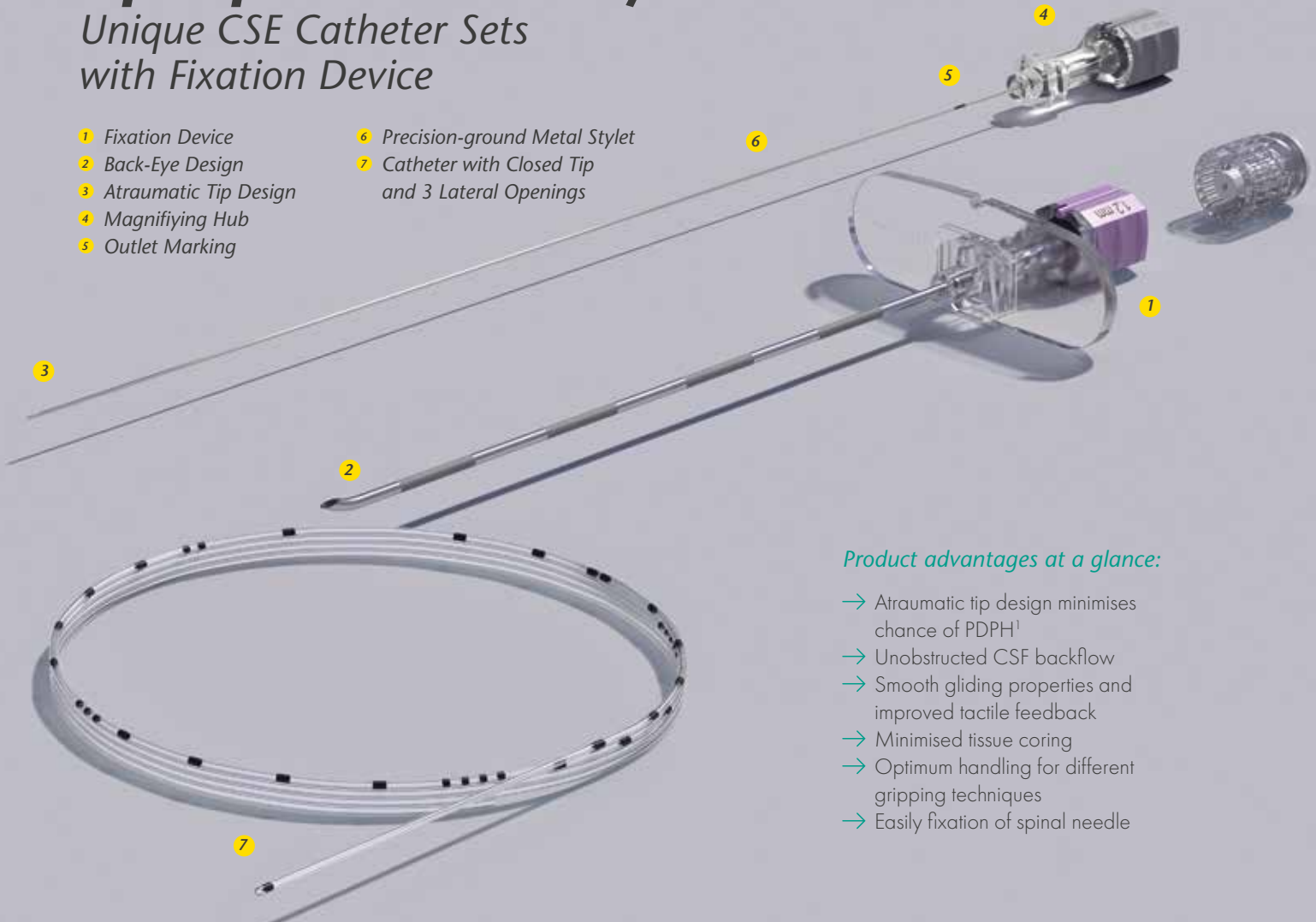

Product advantages at a glance:

- Atraumatic tip design minimises chance of PDPH¹
- Unobstructed CSF backflow
- Smooth gliding properties and improved tactile feedback
- Minimised tissue coring
- Optimum handling for different gripping techniques
- Easily fixation of spinal needle

Description	Catheter	Sprotte	Item no.	NRFit Item no.	PU	Filter	Clamping Adapter	LOR 10 ml
18G x 90 mm (3 1/2")	20G x 90 mm (35")	27G	0021451-30	1022461-30	10	•	•	•

1. Cesarini, M. et al. Sprotte needle for intrathecal anaesthesia for Caesarean section: incidence of postdural puncture headache., *Aesthesia* 1990; 45: 646-658

EpiSpin Lock

Unique CSE Catheter Sets with Locking Mechanism

- 1 Unique Locking System
- 2 Back-Eye Opening
- 3 Atraumatic Tip Design
- 4 Magnifying Hub
- 5 Outlet Marking
- 6 Precision-ground Metal Stylet
- 7 Catheter with Closed Tip and 3 Lateral Openings

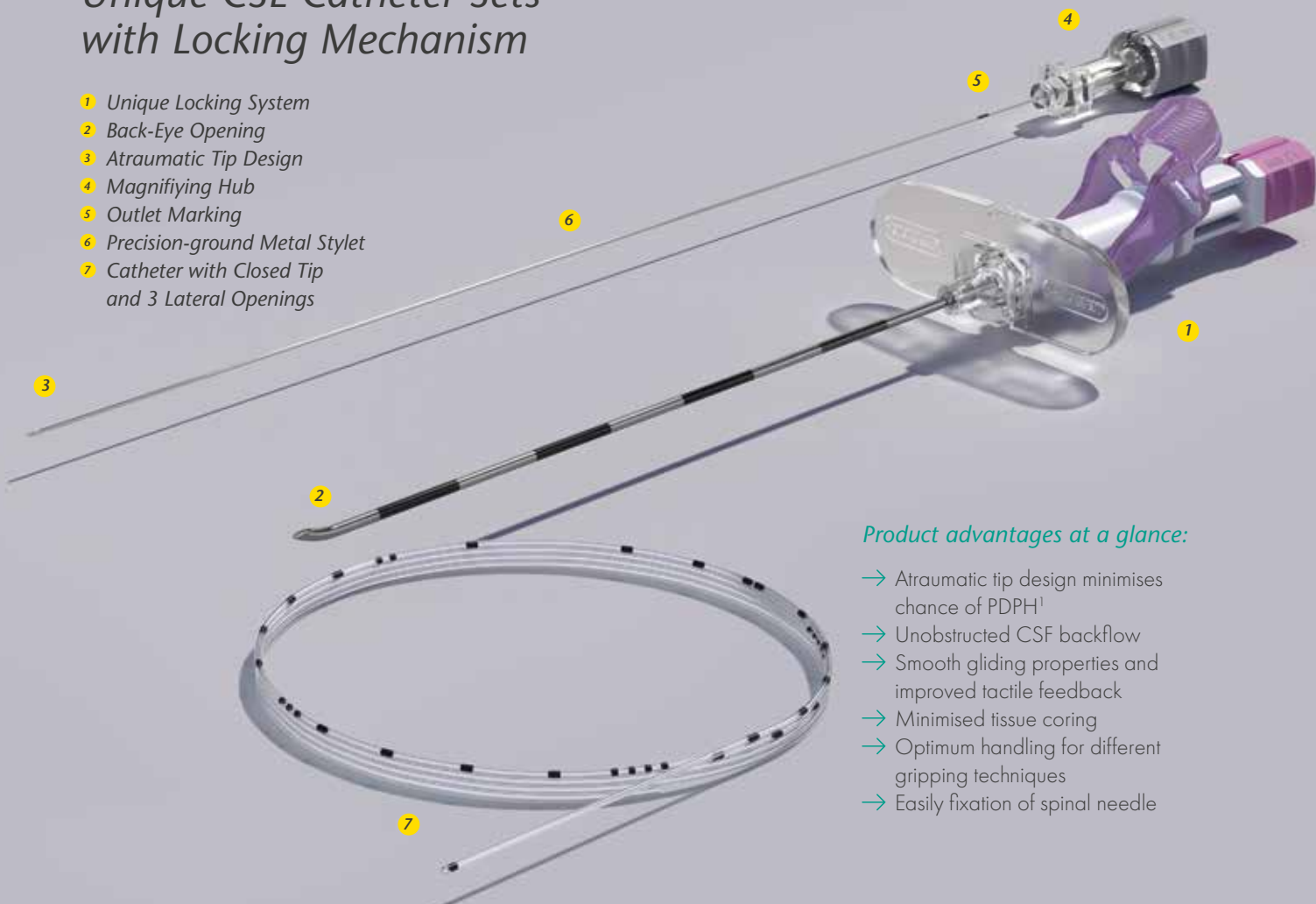

Product advantages at a glance:

- Atraumatic tip design minimises chance of PDPH¹
- Unobstructed CSF backflow
- Smooth gliding properties and improved tactile feedback
- Minimised tissue coring
- Optimum handling for different gripping techniques
- Easily fixation of spinal needle

Description	Catheter	SPROTTE®	Item no.	NRFit® Item no.	PU	FixoLong	Filter	Clamping Adapter	LOR 10 ml
18G x 90 mm (3 1/2")	20G x 90 mm (35")	27G	0021351-30		10		•	•	•
18G x 90 mm (3 1/2")	20G x 90 mm (35")	25G	0021351-18		10		•	•	•
18G x 135 mm (5 3/8")	20G x 90 mm (35")	25G	0121351-18		10		•	•	•
16G x 90 mm (3 1/2")	19G x 90 mm (35")	25G	0021351-17		10	•	•	•	•

EpiSpin Lock Soft

Unique CSE Soft Catheter Sets with Locking Mechanism

- 1 Unique Locking System
- 2 Back-Eye Opening
- 3 Atraumatic Tip Design
- 4 Magnifying Hub
- 5 Outlet Marking
- 6 Precision-ground Metal Stylet
- 7 Soft Catheters
- 8 Integrated Metal Helical Coil
- 9 Catheter with Closed Tip and 6 Lateral Openings

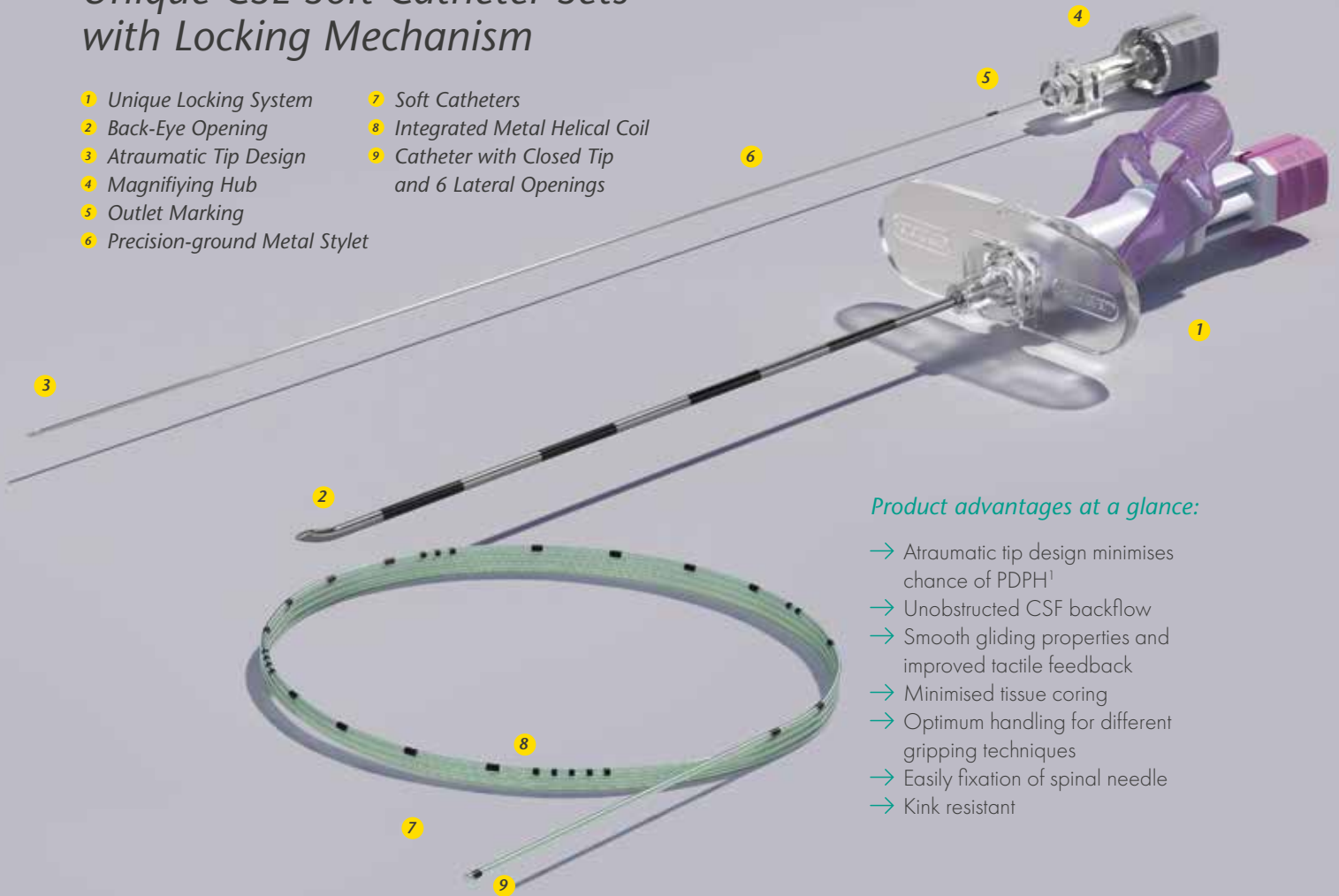

Product advantages at a glance:

- Atraumatic tip design minimises chance of PDPH¹
- Unobstructed CSF backflow
- Smooth gliding properties and improved tactile feedback
- Minimised tissue coring
- Optimum handling for different gripping techniques
- Easily fixation of spinal needle
- Kink resistant

Description	Catheter	Sprotte	Item no.	NRFit Item no.	PU	FixoLong	Filter	Clamping Adapter	LOR 10 ml
18G x 90mm (3 1/2")	20G x 90mm (35")	25G	0021352-18		10		•	•	•

1. Cesarini, M. et al. Sprotte needle for intrathecal anaesthesia for Caesarean section: incidence of postdural puncture headache., *Aesthesia* 1990; 45: 646-658

SonoPlex® II & E-Cath® PROFESSIONAL ANESTHESIA'S FAVORITE POWER COUPLE

Our Product Power Couple is the perfect solution for all of your Single Shot or Continuous Nerve Blocks, offering great visibility, ease-of-use, and the versatility you need.

 MADE IN GERMANY



SonoPlex II/SonoBlock II The Standard for Ultrasound-Guided Single-Shot Nerve Blocks

- Cornerstone Reflectors and NanoLine® coating increase shaft and tip echogenicity
- Newly Optimized Hub
 - Color-coded hub for easy size identification
 - Fixed injection tubing
 - Removable stimulation cord (SonoPlex II)



Excellent visibility
irrespective of
the insertion angle

E-Cath/E-Cath Plus

Nerve Block Catheter Placement as Easy as a Single-Shot

- Catheter over Needle (CON) technique reduces leakage, migration, and kinking
- Cornerstone Reflectors increase visibility during placement
- lengths in 100mm and 150mm

Products are available in customizable procedural trays



OUR TRIAL SAMPLES NOW!
www.fajunkusa.com

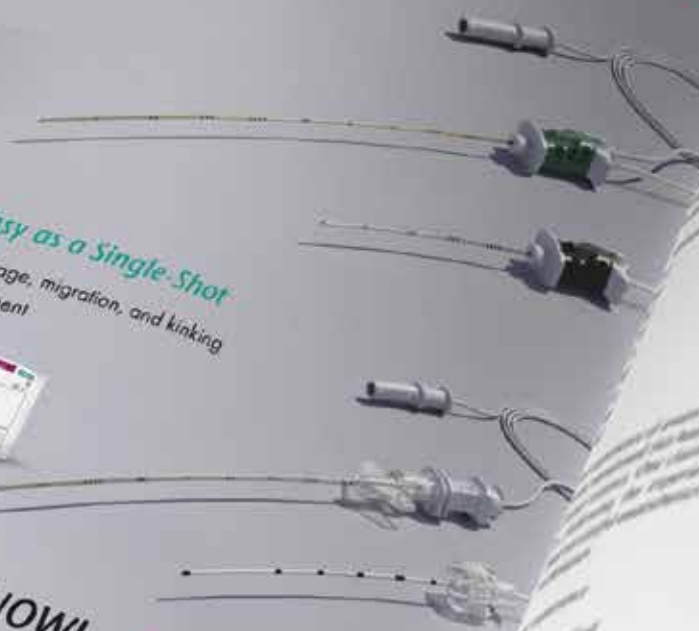

30
43
15
16

Nerve Blocks

*Single Shot and Continuous Products for
Ultrasound and Dual Guided Nerve Blocks*



SonoPlex® II

Echogenic, Stimulating Single Shot Nerve Block Needles

- 1 Echogenic Needle Tip
- 2 Cornerstone Reflectors
- 3 NanoLine® Coating
- 4 Stimulation Cable
- 5 Bevel Configurations (Facet, Facet S, SPROTTE®)
- 6 Removable Stimulation Cable
- 7 Non-Removable Injection Tubing
- 8 Colour-Coded Needle Hub

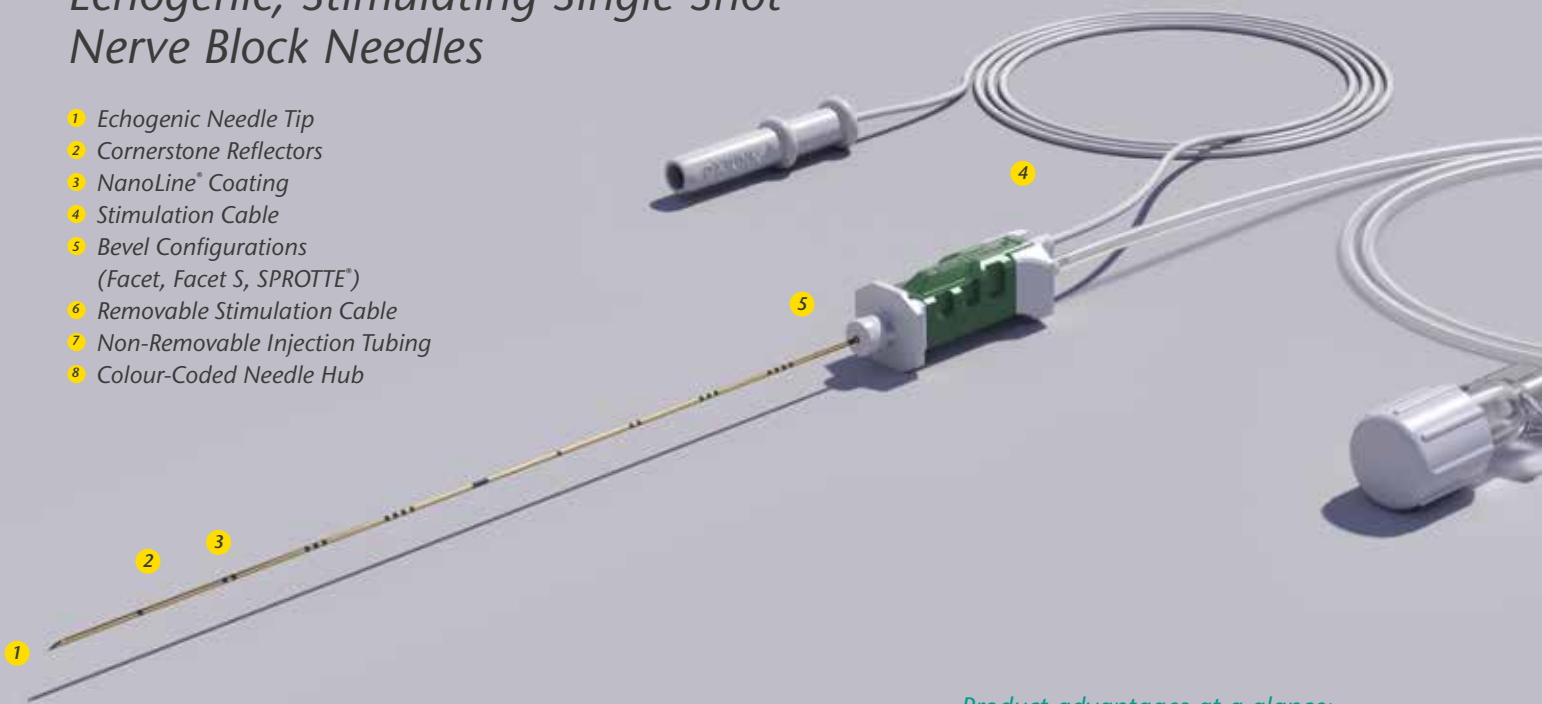

Product advantages at a glance:

- Reliable and optimised needle echogenicity at higher angle
- Optimised ultrasound visibility of needle shaft
- Smooth gliding properties
- Stimulating (Dual Guidance)

SonoPlex II with Facet Tip	Item no.	NRFit® Item no.	PU
• 22G x 40 mm (1 5/8")	001285-70	001265-70	10
• 22G x 50 mm (2")	001285-74	001265-74	10
22G x 80 mm (3 1/5")	001285-71	001265-71	10
21G x 100 mm (4")	001285-77	001265-77	10
20G x 120 mm (4 3/4")	001285-72	001265-72	10
20G x 150 mm (6")	001285-76	001265-76	10

SonoPlex II with Facet S Tip	Item no.	NRFit Item no.	PU
• 25G x 50 mm (2")	001287-81	001267-81	10
• 24G x 40 mm (1 5/8")	001287-78	001267-78	10
• 24G x 50 mm (2")	001287-85	001267-85	10
• 22G x 40 mm (1 5/8")	001287-70	001267-70	10
• 22G x 50 mm (2")	001287-74	001267-74	10
22G x 80 mm (3 1/5")	001287-71	001267-71	10
21G x 100 mm (4")	001287-77	001267-77	10
20G x 120 mm (4 3/4")	001287-72	001267-72	10
20G x 150 mm (6")	001287-76	001267-76	10

- Small patient product

SonoPlex II with Sprotte Tip	Item no.	NRFit Item no.	PU
• 22G x 50 mm (2")	001285-31G	001265-31G	10
22G x 90 mm (3 1/2")	001285-31J	001265-31J	10

SonoBlock II

Echogenic, Non-stimulating Single Shot Nerve Block Needles

- 1 Echogenic Needle Tip
- 2 Cornerstone Reflectors
- 3 NanoLine Coating
- 4 Bevel Configurations (Facet, Facet S, Sprotte)
- 5 Non-Removable Injection Tubing
- 6 Colour-Coded Needle Hub



Product advantages at a glance:

- Reliable and optimised needle echogenicity at higher angle
- Optimised ultrasound visibility of needle shaft
- Smooth gliding properties
- Non-stimulating (Ultrasound Guidance only)

SonoBlock II with Facet Tip	Item no.	NRFit Item no.	PU	SonoBlock II with Facet S Tip	Item no.	NRFit Item no.	PU
• 22G x 50 mm (2")	001280-74	001260-74	10	• 22G x 50mm (2")	001281-74		10
22G x 80 mm (3 1/5")	001280-71	001260-71	10	22G x 80mm (3 1/5")	001281-71		10
21G x 100 mm (4")	001280-77	001260-77	10	21G x 100mm (4")	001281-77		10
				20G x 120mm (4 3/4")	001281-72		10

- Small patient product

SonoTAP[®] II

Echogenic, Non-stimulating Single Shot Fascial Plane Block Needles

- 1 Echogenic Needle Tip
- 2 Cornerstone Reflectors
- 3 Facet Tip
- 4 Non-Removable Injection Tubing
- 5 Colour-Coded Needle Hub



Product advantages at a glance:

- Reliable and optimised needle echogenicity at higher angle
- Optimised ultrasound visibility of needle shaft
- Non-stimulating (Ultrasound Guidance only)

SonoTAP II	Item no.	NRFit [®] Item no.	PU
• 24G x 40mm (1 5/8")	1285-3Y040	1265-3Y040	10
• 24G x 50mm (2")	1285-3Y050	1265-3Y040	10
• 22G x 50mm (2")	1285-3E050	1265-3E050	10
22G x 80mm (3 1/5")	1285-3E080	1265-3E080	10
21G x 110mm (4")	1285-3F110	1265-3F110	10
21G x 150mm (6")	1285-3F150	1265-3F150	10

- Small patient product

TuohySono

Echogenic, Non-stimulating Single Shot Plane Block Needles

- 1 Echogenic Needle Tip
- 2 Cornerstone Reflectors
- 3 Depth Markings
- 4 Precision-ground Metal Stylet
- 5 Detachable Plastic Wings

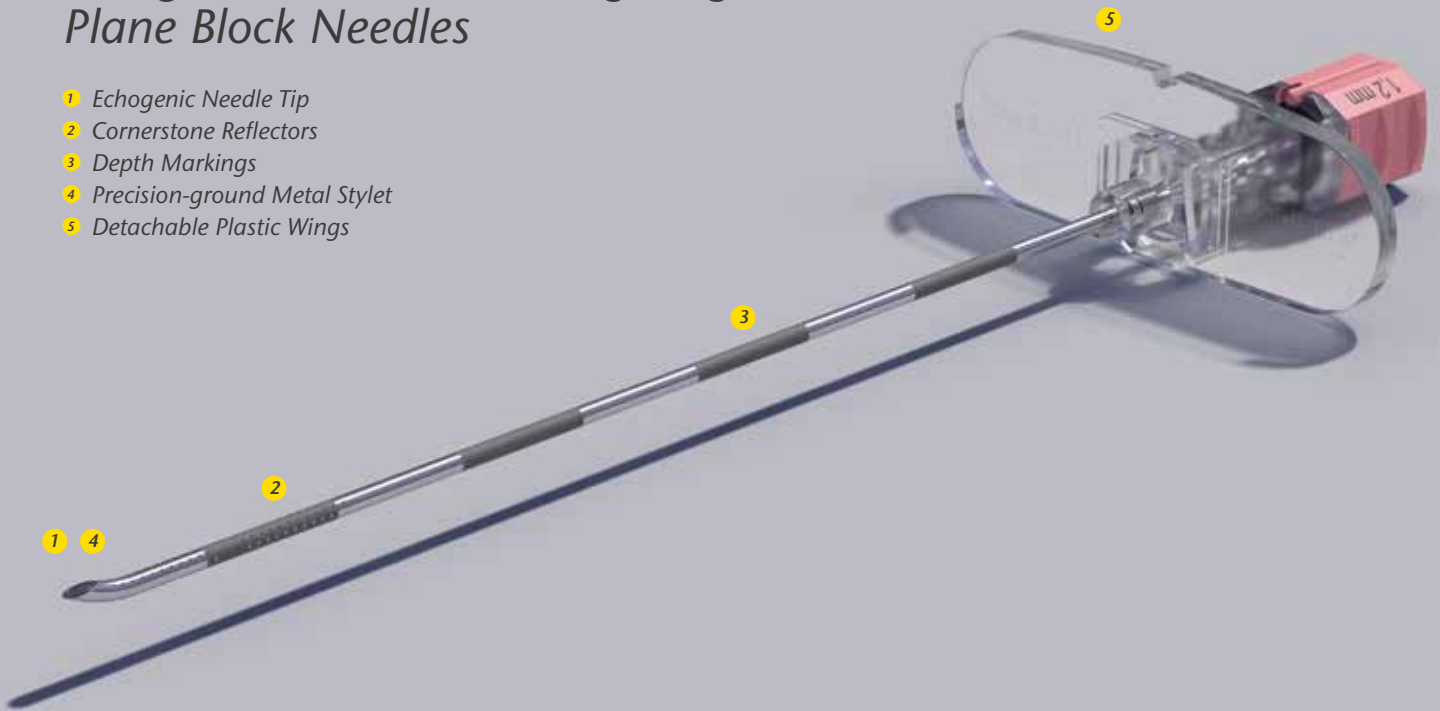

Product advantages at a glance:

- Reliable and optimised needle echogenicity at higher angle
- Optimised ultrasound visibility of needle shaft
- Non-stimulating (Ultrasound Guidance only)

Description	Item no.	PU
21G x 90mm	1085-4F090	25
• 18G x 50mm (2")	1085-4K050	25
18G x 90mm (3 1/2")	1085-4K090	25
18G x 120mm (4 3/4")	1085-4K120	10
17G x 90mm (3 1/2")	1085-4M090	25

- Small patient product

SonoEye

Echogenic Needles for Ultrasound-Guided Retrobulbar Blocks

- 1 Echogenic Needle Tip
- 2 Cornerstone Reflectors
- 3 Aktinson Tip



Product advantages at a glance:

- Reliable needle visualisation at any angle
- Optimised ultrasound visibility of needle shaft

Description	Item no.	PU
24G x 30mm (1 1/5")	1187-7000	10
24G x 40mm (1 5/8")	1187-7001	10

UniPlex®

Stimulating Single Shot Nerve Block Needles

- 1 Echogenic Needle Tip
- 2 NanoLine® Coating
- 3 Stimulation Cable
- 4 Bevel Configurations (Facet, Facet S, SPROTTE®)

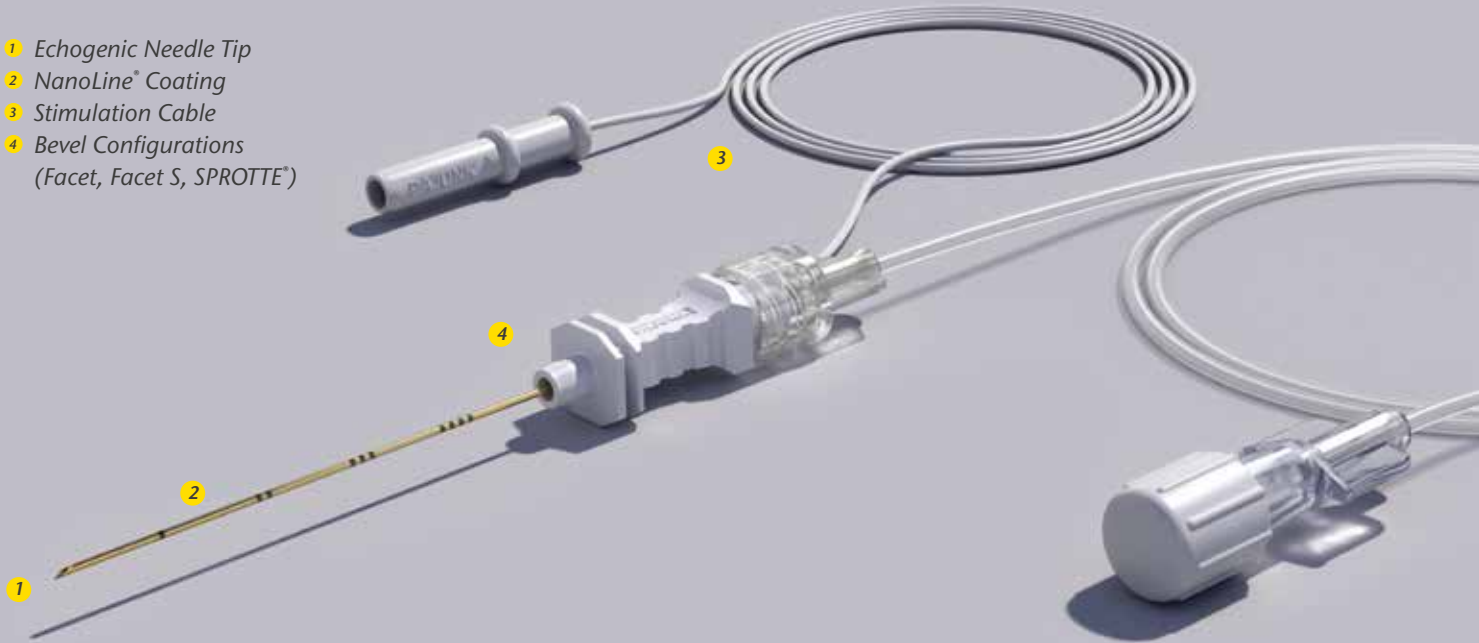

Product advantages at a glance:

- Smooth gliding properties
- Stimulating

UniPlex with Facet Tip	Item no.	NRFit® Item no.*	PU	UniPlex with Facet S Tip	Item no.	NRFit Item no.*	PU
• 25G x 35 mm (1 1/3")	001156-80	001246-80	10	• 24G x 50 mm (2")	001157-81	001247-85	10
• 25G x 50 mm (2")	001156-81	001246-81	10	• 22G x 50 mm (2")	001157-74	001247-74	10
• 22G x 50 mm (2")	001156-74	001246-74	10	22G x 80 mm (3 1/5")	001157-71		10
22G x 80 mm (3 1/5")	001156-71	001246-71	10	21G x 100 mm (4")	001157-77		10
22G x 100 mm (4")	001156-84		10				
22G x 120 mm (4 3/4")	001156-82	001246-82	10	UniPlex with Sprotte Tip	Item no.	NRFit Item no.*	PU
21G x 100 mm (4")	001156-77	001246-77	10	• 22G x 50 mm (2")	001156-31G	001246-31G	10
20G x 120 mm (4 3/4")	001156-72	001246-72	10	22G x 70 mm (2 3/4")	001156-31H	001246-31H	10
20G x 150 mm (6")	001156-76	001246-76	10				

• Small patient product

* with UniPlex II – 2nd generation needle

E-Cath[®] II

Echogenic Catheter-Over-Needle Systems

- 1 Catheter-Over-Needle Technique
- 2 Cornerstone Reflectors
- 3 Echogenic Needle Tip
- 4 NanoLine[®] Coating
- 5 Self Priming System
- 6 Soft Tip
- 7 Stimulation Cable

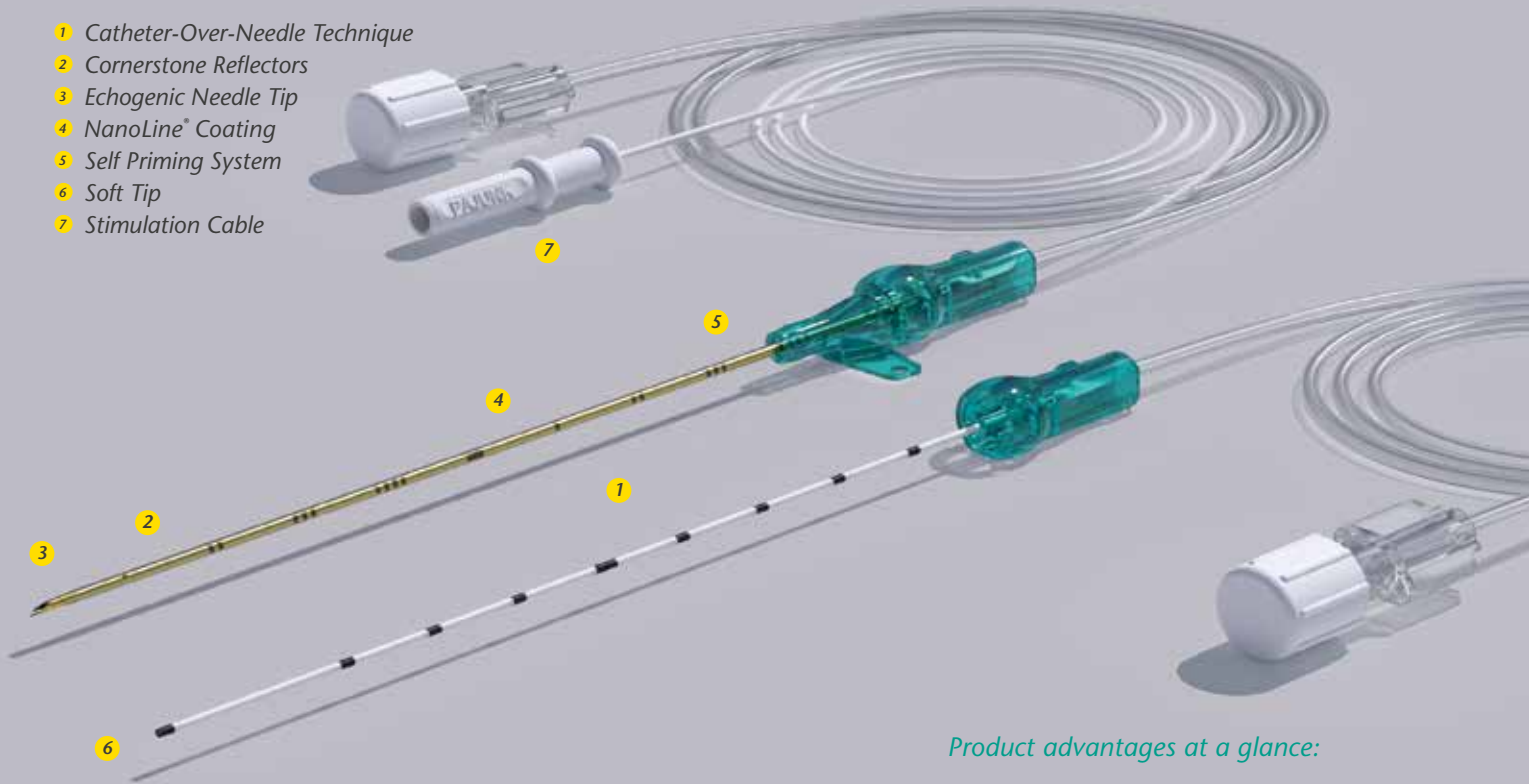

Product advantages at a glance:

- Catheter placement as easy as single shot
- Echogenic system
- Stimulating
- Easy handling

Indwelling catheter	Working Length: Combined indwelling catheter + E-Cath II	Item no.	NRFit [®] Item no.	PU	Fixolong	Filter	FixoCath
18G x 50mm (2")	52mm	301185-40E	301165-40E	10	•	•	
18G x 50mm (2")	52mm	301285-40E	301265-40E	10			•
18G x 80mm (3 1/4")	82mm	311185-40E	311165-40E	10	•	•	
18G x 80mm (3 1/4")	82mm	311285-40E	311265-40E	10			•
18G x 100mm (4")	102mm	361185-40E		10	•	•	
18G x 100mm (4")	102mm	361285-40E		10			•
18G x 130mm (5 2/5")	132mm	351185-40E		10	•	•	
18G x 130mm (5 2/5")	132mm	351285-40E		10			•
18G x 150mm (6")	152mm	371285-40E		10			•

Needle with Cornerstone Reflectors (21G) with Facet S Tip, indwelling catheter and E-Catheter (20G)

E-Cath[®] II Plus

Echogenic Catheter-Over-Needle Systems with Extended E-Catheter Tip

- 1 Catheter-Over-Needle Technique
- 2 Cornerstone Reflectors
- 3 Echogenic Needle Tip
- 4 NanoLine Coating
- 5 Self Priming System
- 6 Stimulation Cable
- 7 Three Lateral Openings
- 8 Extended 15 mm Tip

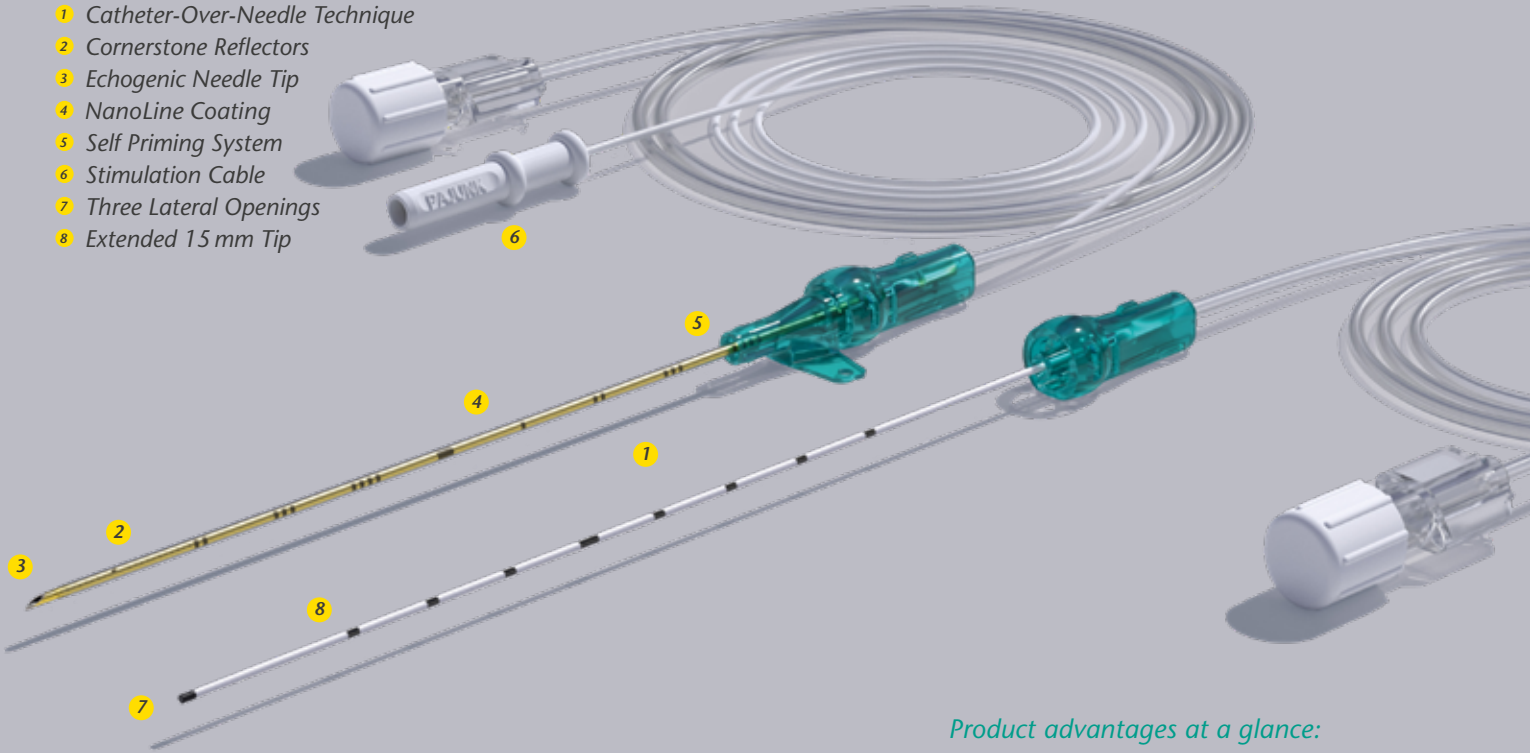

Product advantages at a glance:

- Catheter placement as easy as single shot
- Echogenic system
- Stimulating
- Easy handling

Indwelling catheter	Working Length: Combined indwelling catheter + E-Cath II	Item no.	NRFit [®] Item no.	PU	Fixolong	Filter	FixoCath
18G x 50mm (2")	65mm	301185-41E	301165-41E	10	•	•	
18G x 50mm (2")	65mm	301285-41E		10			•
18G x 80mm (3 1/4")	95mm	311185-41E	311165-41E	10	•	•	
18G x 80mm (3 1/4")	95mm	311285-41E		10			•

Needle with Cornerstone Reflectors (21G) with Facet S Tip, indwelling catheter and E-Catheter (20G) with stylet and 15 mm extended tip

SonoLong Echo

Echogenic Catheter-Through-Needle Systems

- 1 Catheter with Central Opening
- 2 Depth Markings
- 3 Echogenic Needle Tip
- 4 Cornerstone Reflectors
- 5 NanoLine® Coating
- 6 Stimulation Cable
- 7 Bevel Configurations (Facet, Tuohy, SPROTTE®)

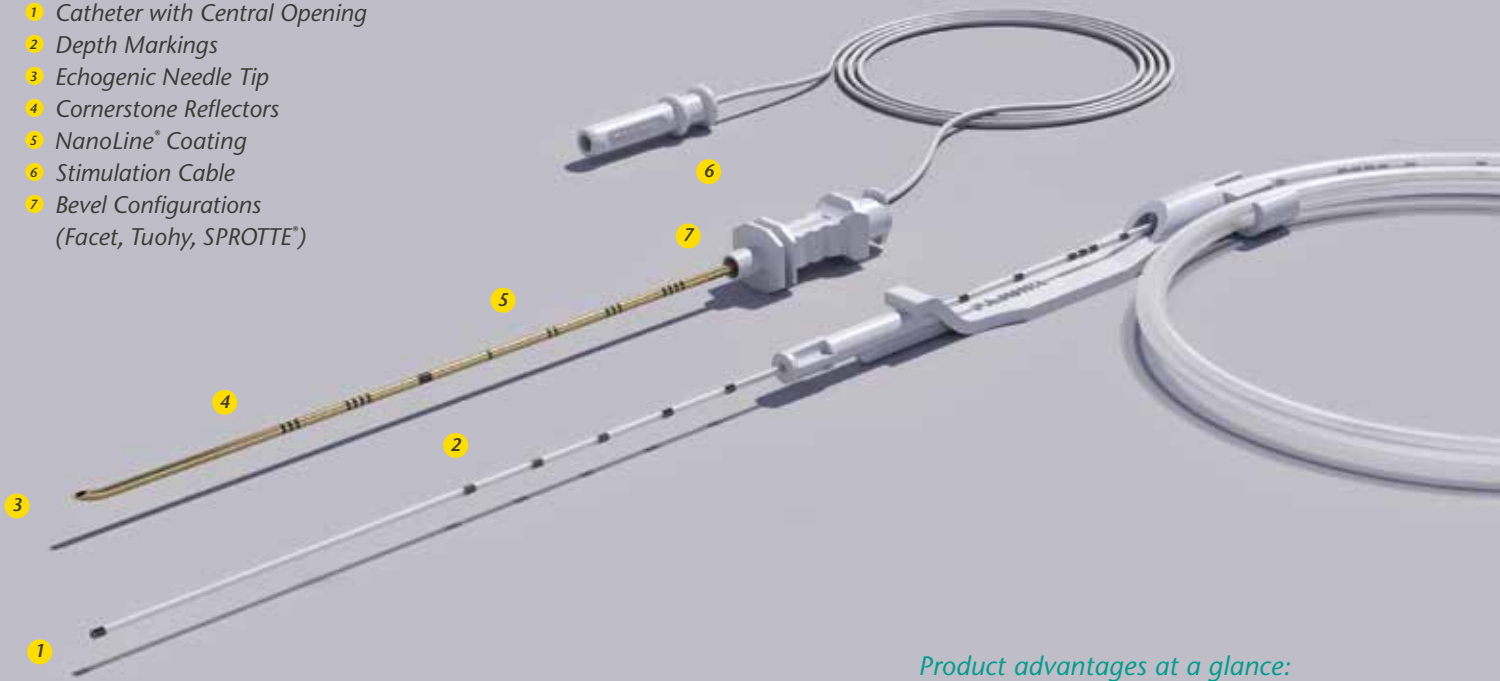

Product advantages at a glance:

- Echogenic plastic catheter
- Catheter dispenser with automatic stylet removal
- Stimulating

SonoLong Echo with Facet Tip	Catheter	Item no.	NRFit® Item no.	PU	FixoLong	Filter	Clamping Adapter
• 19G x 50 mm (2")	20G x 50 cm (20")	531185-31A	531165-31A	10	•	•	•
19G x 75 mm (3")	20G x 50 cm (20")	561185-31A	561165-31A	10	•	•	•
19G x 100 mm (4")	20G x 50 cm (20")	521185-31A	521165-31A	10	•	•	•
19G x 150 mm (6")	20G x 50 cm (20")	511185-31A	511165-31A	10	•	•	•
SonoLong Echo with Tuohy Tip	Catheter	Item no.	NRFit Item no.	PU			
• 18G x 50 mm (2")	20G x 50 cm (20")	531185-31C	531165-31C	10	•	•	•
18G x 100 mm (4")	20G x 50 cm (20")	521185-31C	521165-31C	10	•	•	•
18G x 150 mm (6")	20G x 50 cm (20")	511185-31C	511165-31C	10	•	•	•
SonoLong Echo with Sprotte Special Tip	Catheter	Item no.	NRFit Item no.	PU			
19G x 60 mm (2 1/4")	20G x 50 cm (20")	531185-31B	531165-31B	10	•	•	•
19G x 120 mm (4 3/4")	20G x 50 cm (20")	521185-31B	521165-31B	10	•	•	•

• Small patient product

SonoLong SoftSecure

Echogenic Catheter-Through-Needle Systems with Stainless Steel Helical Coil

- 1 Catheter with Three Lateral Openings
- 2 Stainless Steel Helical Coil
- 3 Depth & Outlet Markings
- 4 Echogenic Needle Tip
- 5 Cornerstone Reflectors
- 6 NanoLine Coating
- 7 Stimulation Cable
- 8 Bevel Configurations (Facet S, Tuohy)

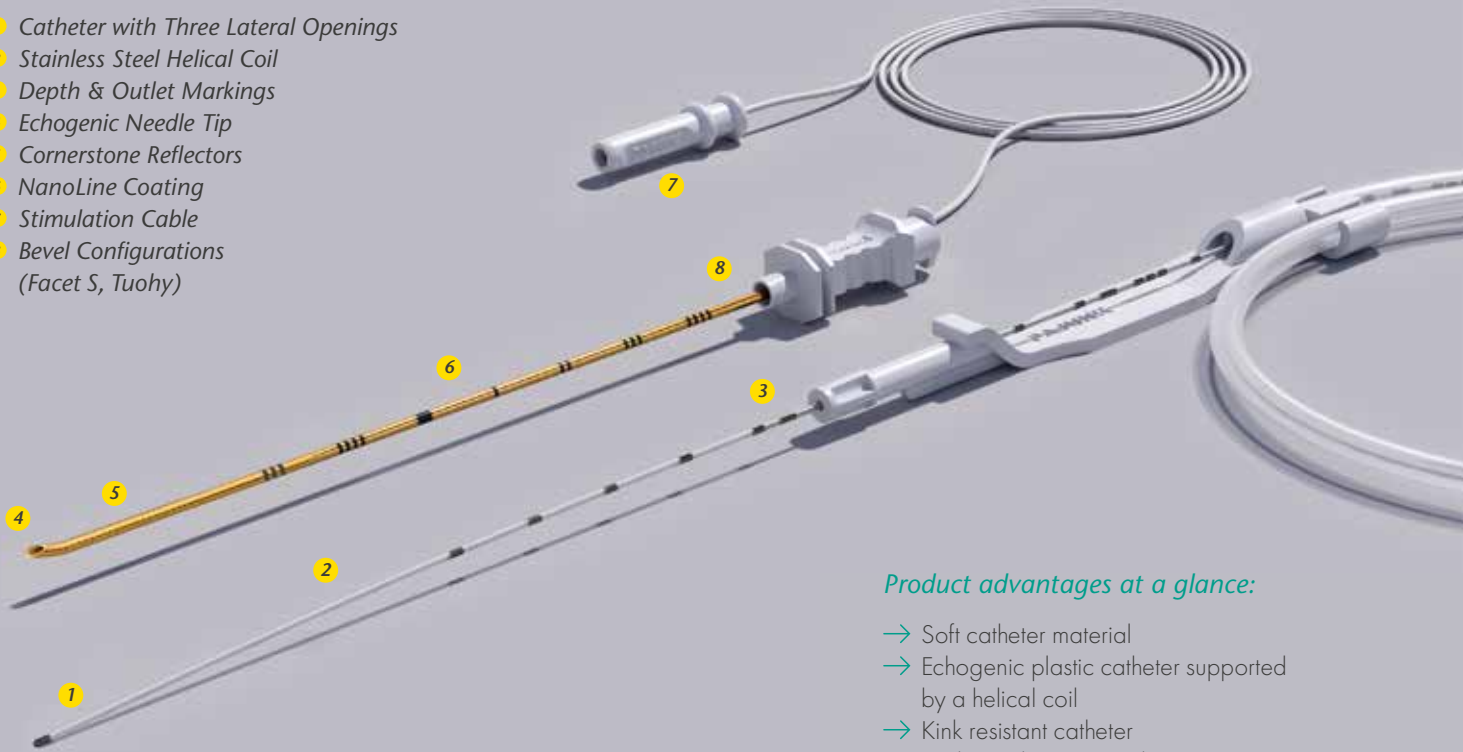

Product advantages at a glance:

- Soft catheter material
- Echogenic plastic catheter supported by a helical coil
- Kink resistant catheter
- Catheter dispenser with automatic stylet removal
- Stimulating

SonoLong SoftSecure with Facet Tip	Catheter	Item no.	NRFit Item no.	PU	FixoLong	Filter	Clamping Adapter
• 19G x 50 mm (2")	20G x 50 cm (20")	531189-31A	531169-31A	10	•	•	•
• 19G x 100 mm (4")	20G x 50 cm (20")	521189-31A	521169-31A	10	•	•	•
• 19G x 150 mm (6")	20G x 50 cm (20")	511189-31A	511169-31A	10	•	•	•

SonoLong SoftSecure with Tuohy Tip	Catheter	Item no.	NRFit Item no.	PU
• 18G x 50 mm (2")	20G x 50 cm (20")	531189-31C	531169-31C	10
• 18G x 100 mm (4")	20G x 50 cm (20")	521189-31C	521169-31C	10

• Small patient product

SonoLong Curl Echo

Echogenic Specialty Catheter-Through-Needle Systems

- 1 Curled Catheter with Closed Tip and 6 Lateral Openings
- 2 Stainless Steel Helical Coil
- 3 Depth Markings
- 4 Echogenic Needle Tip
- 5 Cornerstone Reflectors
- 6 NanoLine® Coating
- 7 Stimulation Cable
- 8 Bevel Configurations (Tuohy)

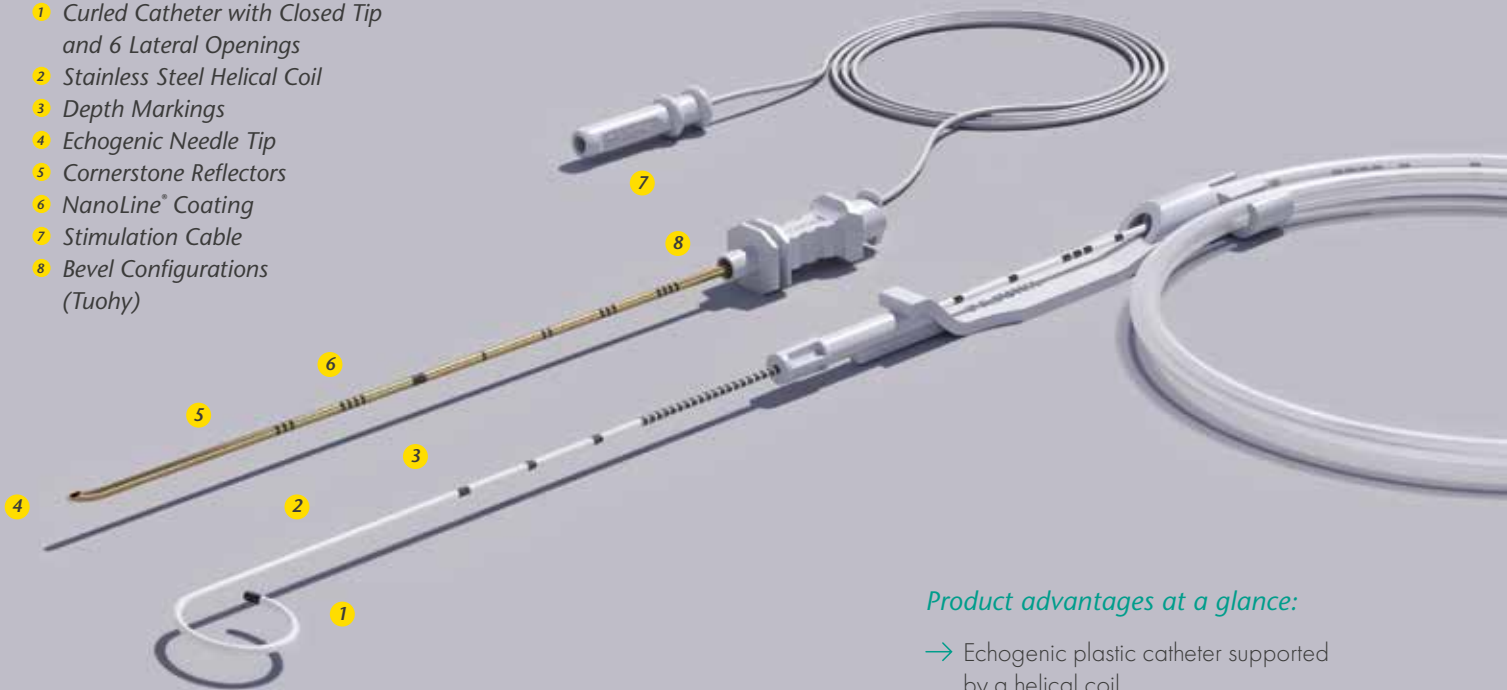

Product advantages at a glance:

- Echogenic plastic catheter supported by a helical coil
- Curled catheter with closed tip and 6 lateral eyes
- Catheter dispenser
- Stimulating

SonoLong Curl Echo with Tuohy Tip	Catheter	Item no.	NRFit® Item no.	PU	FixoLong	Filter	Clamping Adapter
• 18G x 50 mm (2")	20G x 50 cm (20")	531188-31C	531168-31C	10	•	•	•
18G x 100 mm (4")	20G x 90 cm (35")	521188-34C	521168-34C	10	•	•	•

- Small patient product

StimuLong Sono II

Stimulating Catheter-Through-Needle Systems

- 1 Stimulatable Catheter
- 2 Stainless Steel Helical Coil
- 3 Depth Markings
- 4 Echogenic Needle Tip
- 5 Cornerstone Reflectors
- 6 NanoLine Coating
- 7 Stimulation Cable
- 8 Bevel Configurations (Facet, Tuohy)

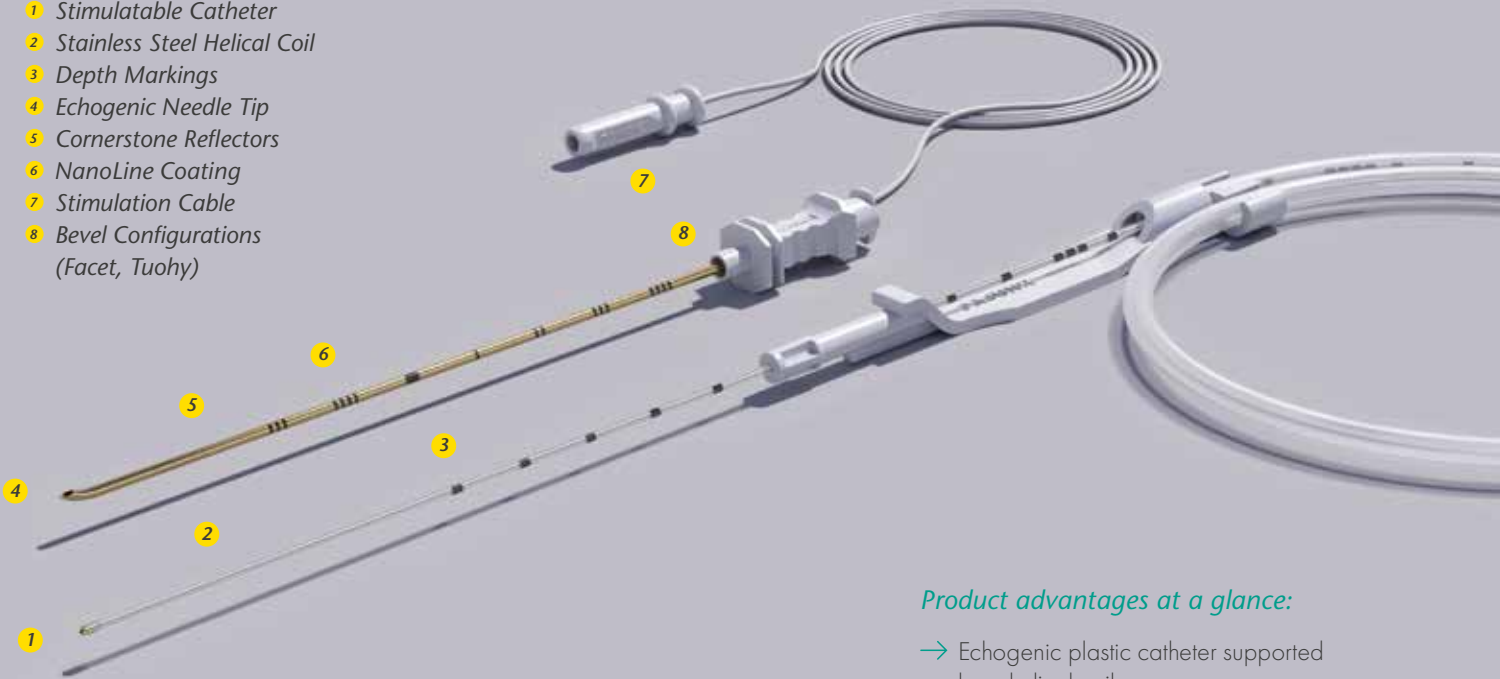

Product advantages at a glance:

- Echogenic plastic catheter supported by a helical coil
- Rounded stimulating catheter tip
- Catheter dispenser with automatic stylet removal
- Stimulating

StimuLong Sono II with Tuohy Tip	Catheter	Item no.	PU	FixoLong	Filter	StimuLong Clamping Adapter	Connecting Cable
• 18G x 50 mm (2")	20G x 50 cm (20")	531187-32C	10	•	•	•	•
• 18G x 100 mm (4")	20G x 50 cm (20")	521187-32C	10	•	•	•	•

StimuLong Sono II with FaceITip	Catheter	Item no.	PU	FixoLong	Filter	StimuLong Clamping Adapter	Connecting Cable
• 19G x 50 mm (2")	20G x 50 cm (20")	531187-32A	10	•	•	•	•
• 19G x 100 mm (4")	20G x 50 cm (20")	521187-32A	10	•	•	•	•

• Small patient product

PlexoLong NanoLine®

Non-echogenic Catheter-Through-Needle Systems

- 1 Catheter with Central Opening
- 2 Depth Markings
- 3 NanoLine Coating
- 4 Stimulation Cable
- 5 Bevel Configurations
(Facet, Tuohy, SPROTTE®)

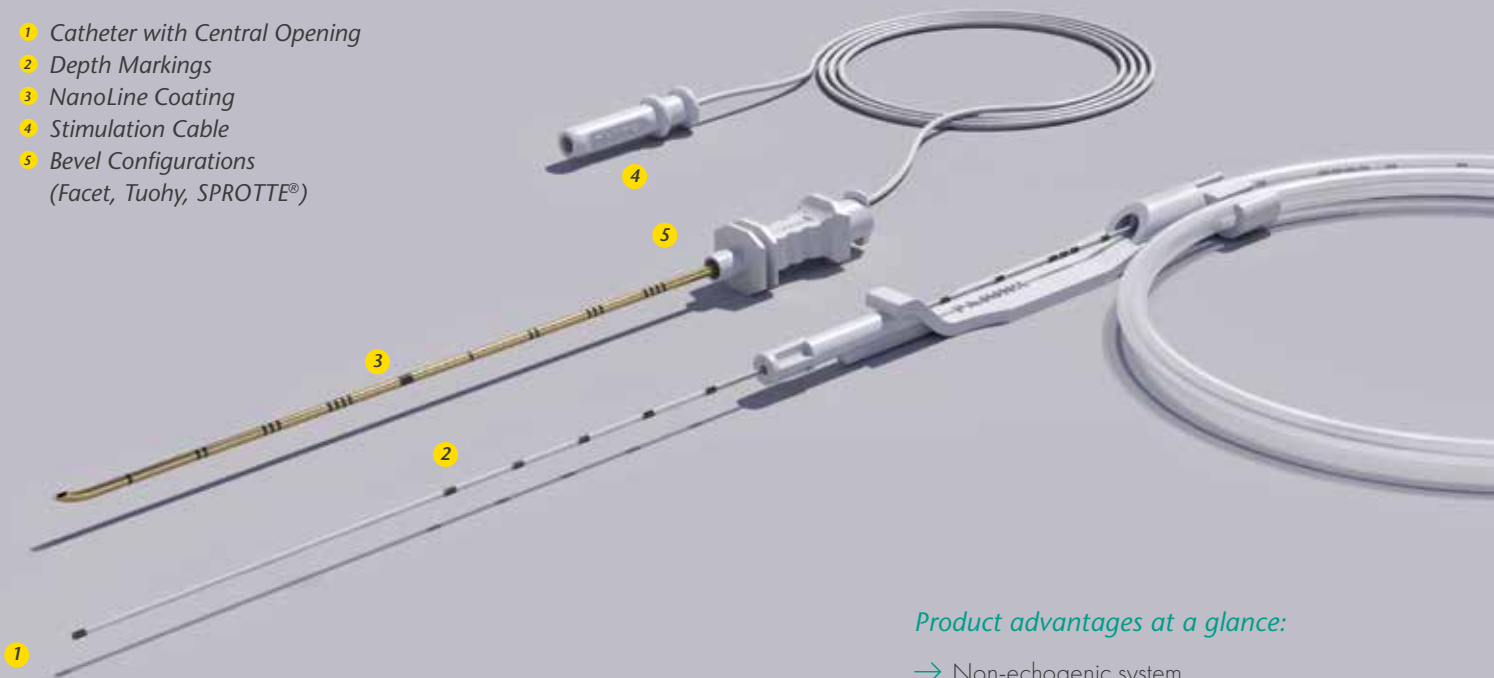

Product advantages at a glance:

- Non-echogenic system
- Catheter dispenser with automatic stylet removal
- Stimulating

PlexoLong NanoLine with Facet Tip	Catheter	Item no.	NRFit® Item no.	PU	FixoLong	Filter	Clamping Adapter
• 19G x 50 mm (2")	20G x 50 cm (20")	531156-31A	531166-31A	10	•	•	•
• 19G x 100 mm (4")	20G x 50 cm (20")	521156-31A	521166-31A	10	•	•	•
• 19G x 150 mm (6")	20G x 50 cm (20")	511156-31A	511166-31A	10	•	•	•
PlexoLong NanoLine with Tuohy Tip	Catheter	Item no.	NRFit Item no.	PU			
• 18G x 50 mm (2")	20G x 50 cm (20")	531156-31C	531166-31C	10	•	•	•
• 18G x 100 mm (4")	20G x 50 cm (20")	521156-31C	521166-31C	10	•	•	•

- Small patient product

A series of horizontal dashed lines for writing notes.

Back on Track in No Time

Wundheilung

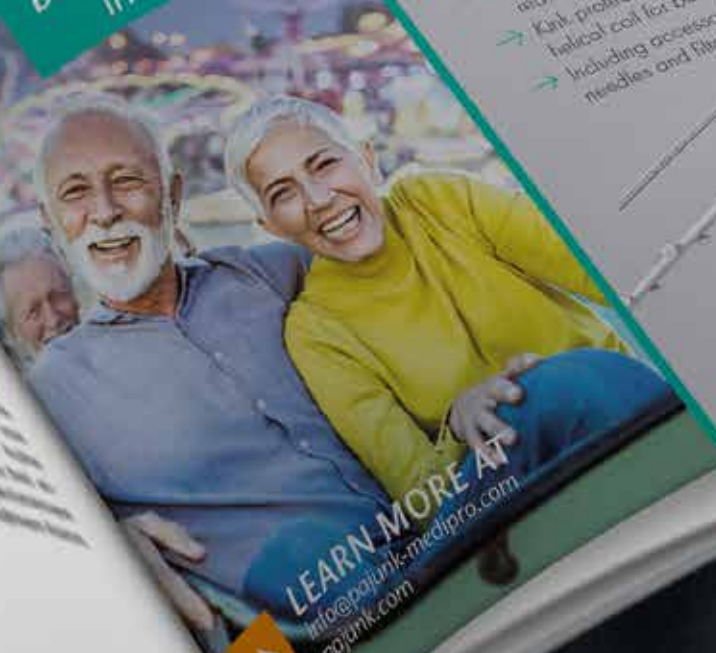

LEARN MORE AT
info@pajunk-medipro.com
pajunk.com

PAJUNK

117yr Tradition. Experience Innovation.

With Pajunk's Continuous Wound Infiltration System

InfiltralLong

- Precise 360° microperforations for consistent homogeneous flow
- More effective pain relief while reducing opioid consumption
- Kink protection hub and stainless steel helical coil for better catheter stability
- Including accessories like introducer needles and filters



FuserPump

- Sturdy 350ml hard shell pump
- Flexible flow rates: 3, 5, 8, 10, 15, 20, 25, 30 ml/hr
- Spring Scale indicates amount of remaining volume

wissenschaftliche Vorteile von bestimmten Funktionen und etablierten Dosisraten auf dem Programm. In zahlreichen Präsentationen haben Studierende zudem die Möglichkeit, die eigene Präsentationsleistung zu präsentieren. Themen wie „Compassion“ (2014) und „Academic Integrity“ werden wieder. Die Diskussionen zeigen, dass es wichtiger ist, die Werte der Gesundheit noch besser zu verankern, als die Werte der Gesundheit zu verbessern. Die Studierenden können die hochbegabten haben, die einen hohen Wert auf die Qualität der Ausbildung legen. Die Studierenden können die Qualität der Ausbildung verbessern, indem sie die Qualität der Ausbildung verbessern. Die Studierenden können die Qualität der Ausbildung verbessern, indem sie die Qualität der Ausbildung verbessern.

Wound Infiltration

*Wide Range of
Wound Infiltration Solutions*



InFiltr

Single Shot Wound Infiltration Needle

- 1 Infiltration Area – Six Lateral Openings
- 2 Closed Needle Tip

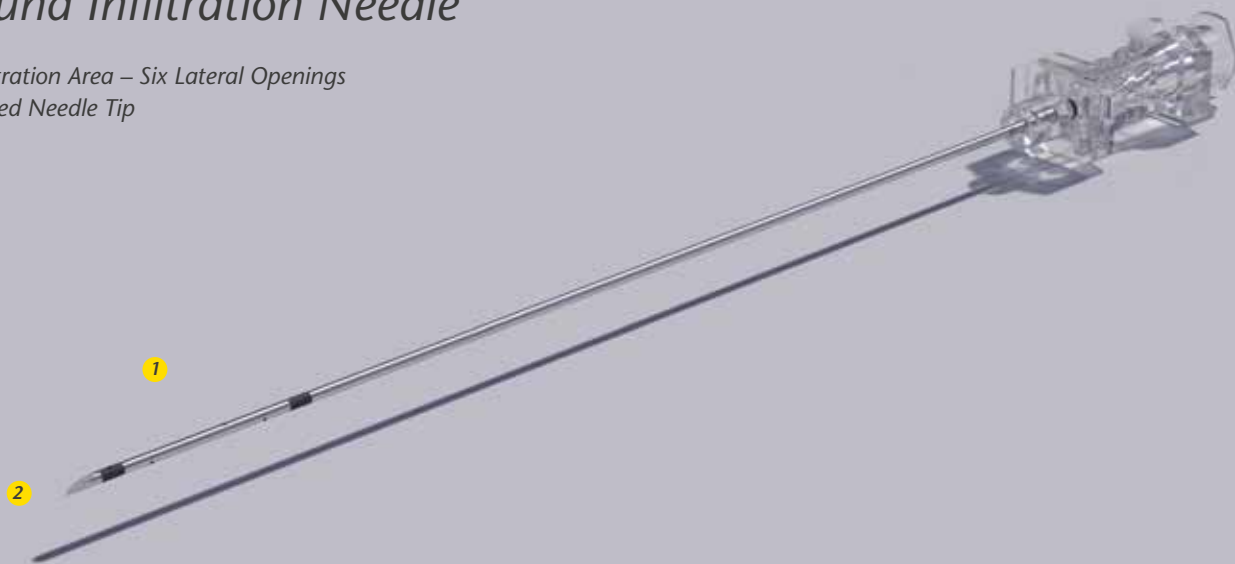

Product advantages at a glance:

- 360 degree arrangement for close, evenly spaced, fine infusion perforations²
- More effective pain relief²
- Infusion reaches its target by the fastest and most direct route²
- Kink resistant

Description	Item no.	PU
20G x 100 mm needle with 6 lateral openings on the first 20 mm	1158-3G100	25

InfiltraLong

Continuous Wound Infiltration Sets

- 1 Precise Microperforation
- 2 Consistent Homogeneous Flow
- 3 Fenestration Area Marking
- 4 Stainless Steel Helical Coil
- 5 Catheter Options – Standard or Forte

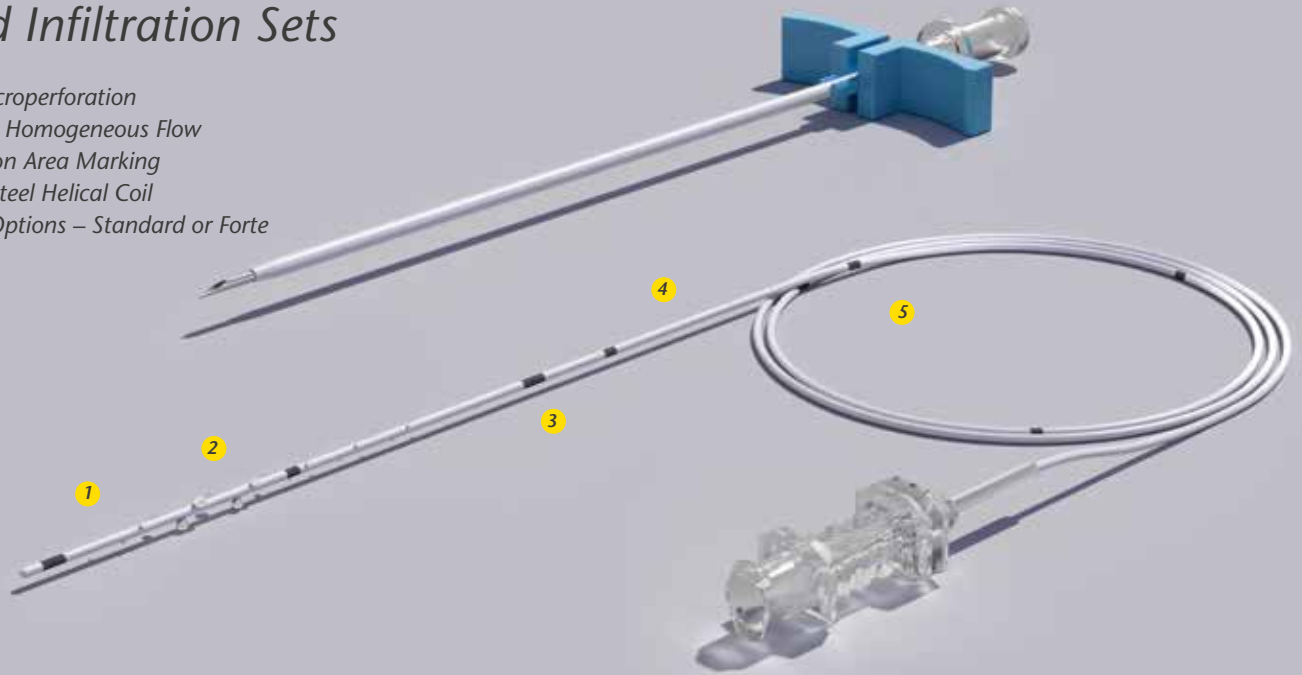

Product advantages at a glance:

- 360 degree arrangement for close, evenly spaced, fine infusion perforations²
- More effective pain relief²
- Infusion reaches its target by the fastest and most direct route²
- Kink resistant

InfiltraLong / InfiltraLong Forte

incl. split needle with puncture needle, Filter, FixoLong

Description	Item no. Standard catheter 19G	Item no. Forte catheter 18G	NRFit® Item no. Forte catheter 18G	PU
InfiltraLong 420 InfiltraLong catheter 420 mm (16 1/2"), with flexible helical coil and 10 openings along the first 25 mm	001158-00D			10
InfiltraLong (Forte) 420 InfiltraLong catheter 420 mm (16 1/2"), with flexible helical coil and 15 openings along the first 40 mm	001158-00Z	001158-01Z	001168-01Z	10
InfiltraLong (Forte) 500 InfiltraLong catheter 500 mm (19 1/2"), with flexible helical coil and 30 openings along the first 75 mm	001158-10A	001158-11A	001168-11A	10
InfiltraLong (Forte) 600 InfiltraLong catheter 600 mm (23 1/2"), with flexible helical coil and 60 openings along the first 150 mm	001158-20B		001168-21B	10
InfiltraLong (Forte) 600 InfiltraLong catheter 600 mm (23 1/2"), with flexible helical coil and 45 openings along the first 100 mm	001158-20D		001168-21D	10
InfiltraLong (Forte) 700 InfiltraLong catheter 700 mm (27 1/2"), with flexible helical coil and 88 openings along the first 220 mm	001158-30C		001168-31C	10
InfiltraLong (Forte) 900 InfiltraLong catheter 900 mm (35 2/5"), with flexible helical coil and 88 openings along the first 300 mm	001158-40C		001168-41D	10

InfiltraLong TUN

Continuous Wound Infiltration Sets with Pre-attached Tunneler

- 1 Pre-attached Curved Tunneler
- 2 Precise Microperforation
- 3 Consistent Homogeneous Flow
- 4 Fenestration Area Marking
- 5 Stainless Steel Helical Coil
- 6 Catheter Options – Standard or Forte

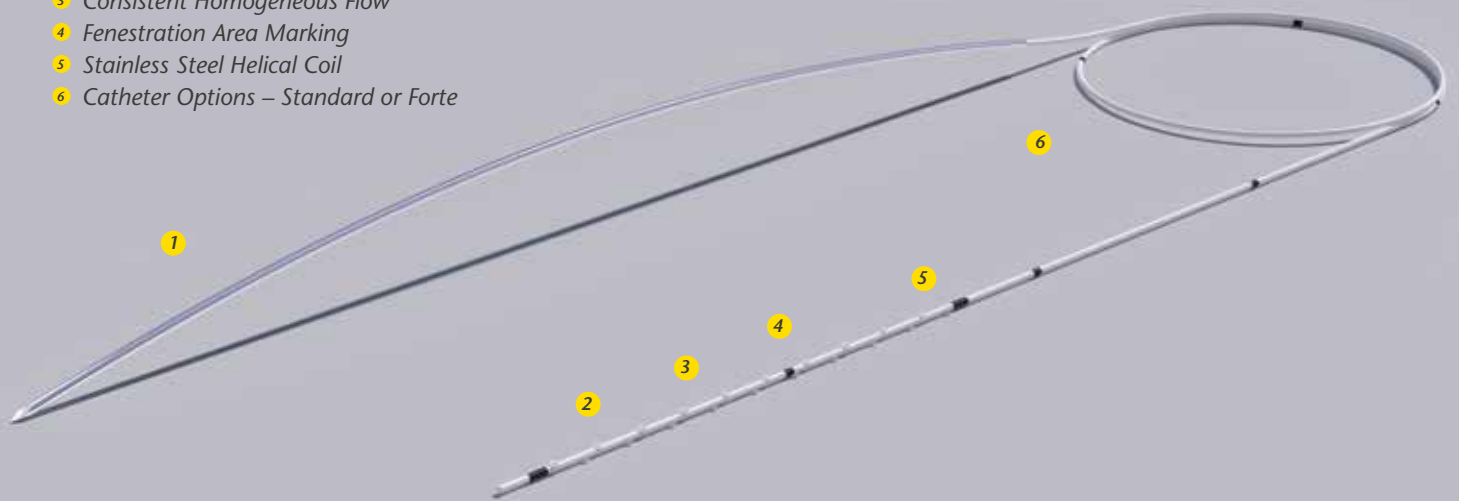

Product advantages at a glance:

- 360 degree arrangement for close, evenly spaced, fine infusion perforations²
- More effective pain relief²
- Infusion reaches its target by the fastest and most direct route²
- Kink resistant

InfiltraLong TUN / InfiltraLong TUN Forte

incl. pre-attached curved tunneler, Clamping Adapter, Filter, FixoLong

Description	Item no. Standard catheter 19G	NRFit® Item no. Forte catheter 18G	PU
InfiltraLong TUN (Forte) 420T InfiltraLong catheter 420 mm (16 1/2"), with flexible helical coil and 10 openings along the first 25 mm	021159-00D	021169-01D	10
InfiltraLong TUN 420T InfiltraLong catheter 420 mm (16 1/2"), with flexible helical coil and 15 openings along the first 40 mm	021159-00Z		10
InfiltraLong TUN (Forte) 600T InfiltraLong catheter 600 mm (23 1/2"), with flexible helical coil and 60 openings along the first 150 mm	021159-20B	021169-21B	10
InfiltraLong TUN (Forte) 600T InfiltraLong catheter 600 mm (23 1/2"), with flexible helical coil and 45 openings along the first 100 mm	021159-20D	021169-21D	10
InfiltraLong (Forte) 700T InfiltraLong catheter 700 mm (27 1/2"), with flexible helical coil and 88 openings along the first 220 mm	021159-30C		10
InfiltraLong (Forte) 900T InfiltraLong catheter 900 mm (35 1/2"), with flexible helical coil and 88 openings along the first 300 mm	021159-40C		10

InfiltraLong TUN Duo

Continuous Wound Infiltration Set
with Tunneler and 2 Catheters

- 1 Pre-attached Curved Tunneler
- 2 Precise Microperforation
- 3 Consistent Homogeneous Flow
- 4 Fenestration Area Marking
- 5 Stainless Steel Helical Coil
- 6 Catheter Options – Standard or Forte

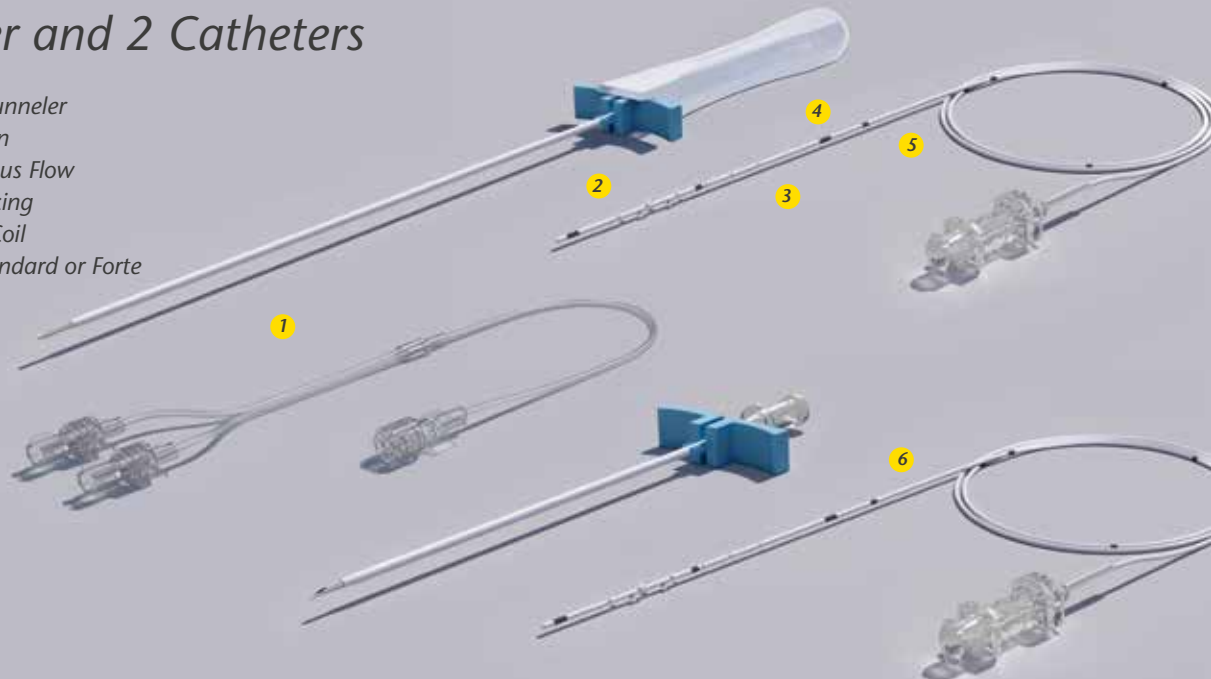

Product advantages at a glance:

- 360 degree arrangement for close, evenly spaced, fine infusion perforations²
- More effective pain relief²
- Infusion reaches its target by the fastest and most direct route²
- Kink resistant

InfiltraLong TUN Duo

Description

Item no. Standard catheter 19G PU

InfiltraLong TUN Duo

- 2x InfiltraLong catheter 19G x 600mm with integrated stainless steel helical coil and 60 openings along the first 150mm, with 360° markings
- 1x Injection tube with Y-connector
- 1x Filter
- 1x FixoLong
- 1x Tunneler 235
- 1x Split needle
- 1x Luer-lock syringe 20ml
- 2x transparent adhesive

021154-20B 3

2. Campolo M., Molin D., Rawal N., Soldati A. Protocols to compare infusion distribution of wound catheters, Med. Eng. Phys. 2011 Apr; 34(3): 326–332

FuserPump (Individual)

Continuous Wound Infiltration Pump

- 1 Hard Shell Pump, 350 ml
- 2 Flexible Flow Rate
- 3 Carrying Pouch
- 4 Spring Scale



Product advantages at a glance:

- Possible virtual check: shatter-proof, clear shell
- Variable flow rates

FuserPump

Description	Item no.	NRFit® Item no.*	PU
FuserPump 350 ml with Carrying Pouch, Spring Scale, Syringe 50ml Lock	1157-00-00	1167-00-00	3
FuserPump Filler Filling system for FuserPump with non-return valve, spike	001151-38L		10

*with Spike NRFit

FuserPump

Continuous Wound Infiltration Sets with FuserPump

- 1 Hard Shell Pump, 350 ml
- 2 Flexible Flow Rate
- 3 Precise Microperforation
- 4 Consistent Homogeneous Flow
- 5 Fenestration Area Marking
- 6 Stainless Steel Helical Coil
- 7 Catheter Options – Standard or Forte



Product advantages at a glance:

- 360 degree arrangement for close, evenly spaced, fine infusion perforations²
- More effective pain relief²
- Infusion reaches its target by the fastest and most direct route²
- Kink resistant
- Possible virtual check: shatter-proof, clear shell
- Variable flow rates

Forte FuserPump / FuserPump Forte

incl. split needle with puncture needle, Filter, FixoLong, FuserPump 350ml, 50ml syringe, spring scale

Description	Item no. Standard catheter 19G	Item no. Forte catheter 18G	NRFit Item no. Forte catheter 18G	PU
FuserPump (Forte) 420 InfiltralLong catheter 420 mm (16 1/2"), with flexible helical coil and 15 openings along the first 40 mm	001157-00Z	001157-01Z	101167-01Z	3
FuserPump (Forte) 500 InfiltralLong catheter 500 mm (19 2/3"), with flexible helical coil and 30 openings along the first 75 mm	001157-10A	001157-11A	101167-11A	3
FuserPump (Forte) 600 InfiltralLong catheter 600 mm (23 1/2"), with flexible helical coil and 60 openings along the first 150 mm	001157-20B	001157-21B	101167-21B	3
FuserPump 600 InfiltralLong catheter 600 mm (23 1/2"), with flexible helical coil and 45 openings along the first 100 mm	001157-20D			3
FuserPump (Forte) 700 InfiltralLong catheter 700 mm (27 1/2"), with flexible helical coil and 88 openings along the first 220 mm	001157-30C		101167-31C	3
FuserPump 900 InfiltralLong catheter 900 mm (35 1/2"), with flexible helical coil and 88 openings along the first 300 mm	001157-40C			3

2. Campolo M., Molin D., Rawal N., Soldati A. Protocols to compare infusion distribution of wound catheters, Med. Eng. Phys. 2011 Apr; 34(3): 326–332

FuserPump TUN

Continuous Wound Infiltration Sets with FuserPump and Tunneler

- 1 Pre-attached Curved Tunneler
- 2 Hard Shell Pump, 350 ml
- 3 Flexible Flow Rate
- 4 Precise Microperforation
- 5 Consistent Homogeneous Flow
- 6 Fenestration Area Marking
- 7 Stainless Steel Helical Coil
- 8 Catheter Options – Standard or Forte



Product advantages at a glance:

- 360 degree arrangement for close, evenly spaced, fine infusion perforations²
- More effective pain relief²
- Infusion reaches its target by the fastest and most direct route²
- Kink resistant
- Possible virtual check: shatter-proof, clear shell
- Variable flow rates

FuserPump TUN

incl. pre-attached curved tunneler, Clamping Adater, Filter, FixoLong, FuserPump 350ml, 50ml syringe, spring scale

Description	Item no. Standard catheter 19G	PU
FuserPump TUN 420T InfiltraLong catheter 420 mm (16 1/2"), with flexible helical coil and 15 openings along the first 40 mm	021157-00Z	3
FuserPump TUN 500T InfiltraLong catheter 500 mm (19 2/3"), with flexible helical coil and 30 openings along the first 75 mm	021157-10A	3
FuserPump TUN 600T InfiltraLong catheter 600 mm (23 1/2"), with flexible helical coil and 60 openings along the first 150 mm	021157-20B	3

Accessories

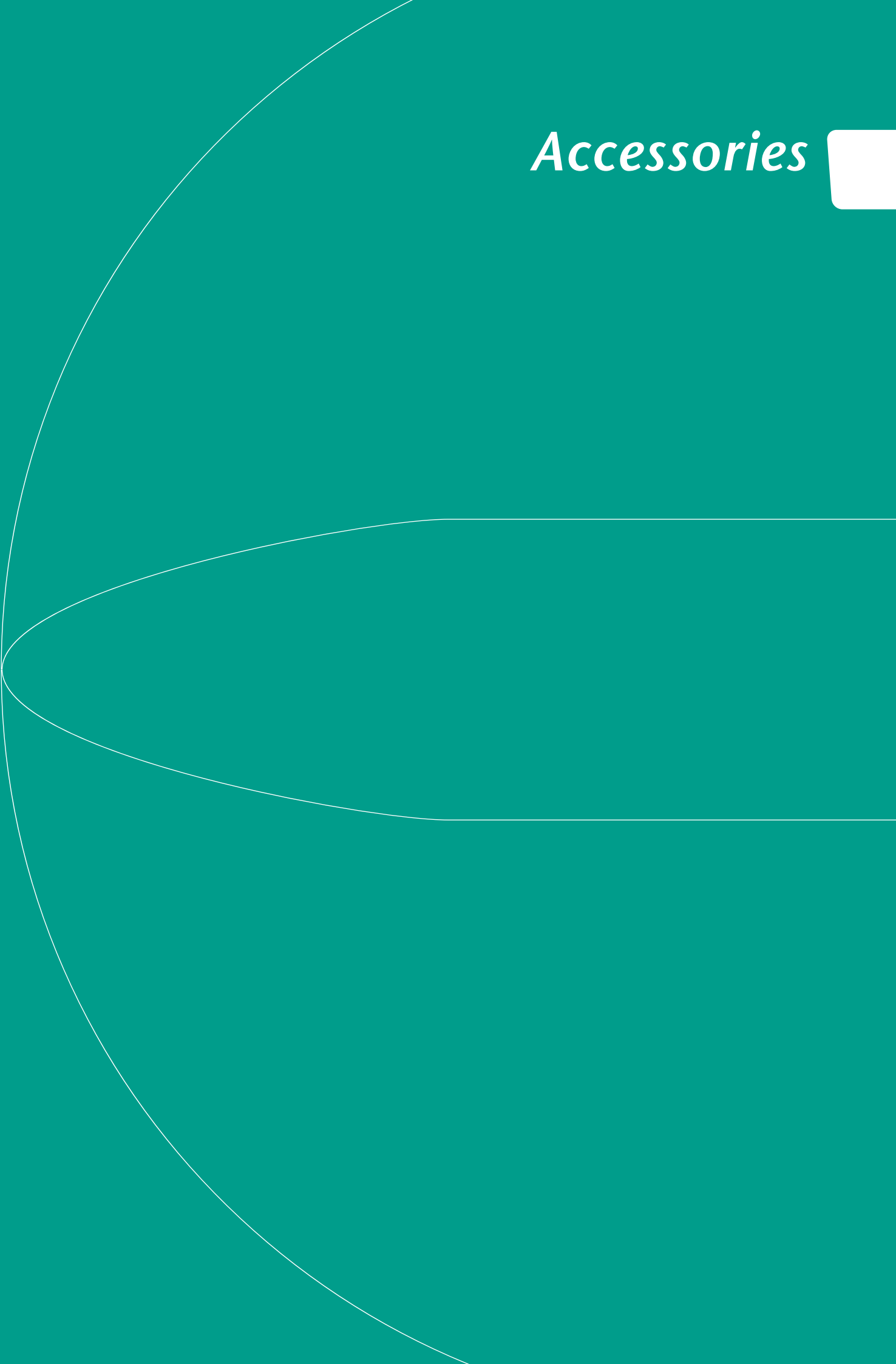

LOR, NerveGuard, FuserPump Filler, Clamping Adapter, FixoCath, Filter & FixoLong, Injection Tubing, NRFit® Accessories, SonoCover

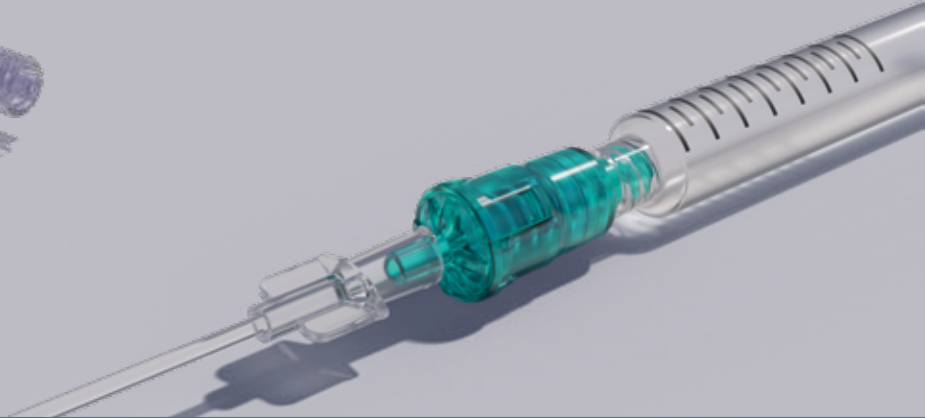

LOR Syringe	Item no.	NRFit Item no.	PU
LOR Syringe, Lock	0001151-45		10
LOR Syringe, Slip		0001166-45	10
NerveGuard	Item no.	NRFit Item no.	PU
for single shot applications in diameters of 20G/21G/22G	001151-38M	001163-38M	10
FuserPump Filler	Item no.	PU	
FuserPump Filler Filling system for FuserPump with non-return valve, spike	001151-38L	10	

Accessories	Item no.	NRFit Item no.	PU
Clamping Adapter grey*		001163-39C	10
Clamping Adapter white**	001151-38C	001163-38C	10
Clamping Adapter yellow***	001151-37V	001163-37V	10
Clamping Adapter green****	001151-37Y		10
FixoCath	001151-37Z		10
Filter	001151-37Q	001163-62	10
FixoLong	001151-47	001163-60	10
FixoLong with Filter	001151-48	001163-61	10
Injection Tubing 60 cm (23")	001151-37R	001163-37R	10
Injection Tubing 35 cm (14") with Y-connection	001151-37W		10

* InfiltraLong Forte 18G
 ** EpiLong Soft 19G / EpiLong & EpiLong Tuohy 19G + 20G / EpiSpin 19G + 20G / InfiltraLong 19G
 *** EpiLong Soft 20G / Nerve Block Catheters 20G and higher
 **** IntraLong 25G + 27G (27G applies to NRFit only)

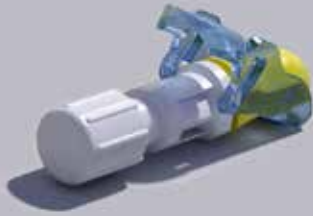

NRFit Accessories	NRFit Item no.	PU	SonoCover – Ultrasound Cover	Item no.	PU
Blood Patch Set			15 x 100 cm (40")		
Tuohy needle NRFit 18G x 90 mm (3 1/2") with metall stylet, injection needle 60 cm (2 1/4"), 2 syringe	001166-942	5	with 3D chamber at the tip, one stripe and two rubbers, sterile	011151-1501	25
20 ml NRFit Slip, syringe 5 ml Luer Slip, LOR syringe 10 ml NRFit Slip, injection needle 21G x 38 mm (1 1/2") green, injection			15 x 30 cm (12")		
needle 25G x 25 mm (1") orange, filter needle 18G x 50 mm (2"), filter needle NRFit 18G x 50 mm (2"), two-way stopcock, cotton swab tweezers, 6 round swabs, 4 compress, fenestrated drape, surgical drape			with 3D chamber at the tip, one stripe and two rubbers, sterile	011151-1530	25
			15 x 60 cm (23 1/2")		
			with 3D chamber at the tip, one stripe and two rubbers, sterile	011151-1560	25
Filter Needle 18G x 50 mm (2")	001163-38Y	10	15 x 100 cm (40")		
Locking Cap male, yellow	001163-38S	10	with gel, one stripe and two rubbers, sterile	021151-1501	25
Locking Cap female, yellow	001163-38Z	10	15 x 30 cm (12")		
			with gel, one stripe and two rubbers, sterile	021151-1530	25
			15 x 60 cm (23 1/2")		
			with gel, one stripe and two rubbers, sterile	021151-1560	25
SonoCover – Ultrasound Cover	Item no.	PU	15 x 100 cm (40")		
			with gel, one stripe and two rubbers, sterile	031151-1501	25
15 x 100 cm (40")	001151-1501	25	15 x 30 cm (12")		
with one stripe and two rubbers, sterile			with gel, one stripe and two rubbers, sterile	031151-1530	25
15 x 30 cm (12")	001151-1530	25	15 x 60 cm (23 1/2")		
with one stripe and two rubbers, sterile			with gel, one stripe and two rubbers, sterile	031151-1560	25
15 x 60 cm (23 1/2")	001151-1560	25			
with one stripe and two rubbers, sterile					

PAJUNK®

PAJUNK® GmbH Medizintechnologie
International Sales
Karl-Hall-Straße 1
78187 Geisingen, Germany
Tel.: +49 7704 9291-0
Fax: +49 7704 9291-600
info@pajunk.com
pajunk.com

PAJUNK® Medical Produkte GmbH
Central Europe
Pajunkstraße 2
78187 Geisingen, Germany
Tel.: +49 7704 8008-0
Fax: +49 7704 8008-150
info@pajunk-medipro.com
pajunk.de & pajunk.eu

PAJUNK® Swiss AG
Switzerland
Neuhofstrasse 5A
6340 Baar, Switzerland
Tel.: +41 41 760 96 27
info@pajunk.ch
pajunk.ch

PAJUNK® Medical System L.P.
United States of America
4575 Marconi Drive
Alpharetta, GA 30005, USA
Tel.: +1 770.493.6832
Fax: +1 678.514.3388
info@pajunk-usa.com
pajunkusa.com

PAJUNK® UK Medical Products Ltd
United Kingdom
Unit D1 The Waterfront
Goldcrest Way, Newburn Riverside
Newcastle upon Tyne, NE15 8NY, UK
Tel.: +44 191 264 7333
info@pajunk.co.uk
pajunk.co.uk